

# Tetzaveh

“You shall command”

Exodus 27:20 - 30:10

Katan Aleph



In This Edition:

20.1 - Blueprints for the Set-apart Garments  
Exodus 28



---

# Table of Contents

---

Parsha Pearls is a comprehensive resource that allows for complete customization by the parent. We understand that if you were to strive to accomplish all aspects of each lesson in one day it would be unrealistic and also overload for the child. It is our intention that this be used 'a la carte' so that it suits your specific needs. Our site caters to printing only the pieces you choose.

This page will provide quick links to get to the portion of the document for which you are looking. When you hover over the title a finger will appear. Click on it and you will be taken directly to that page.

If you are new to Parsha Pearls, we have created an [Introduction](#) document outlining how to use our lessons, as well as a [Scriptural Inspiration](#) document, which explains our titles and the Scriptural inspiration for them. We pray that Parsha Pearls blesses your home and that your children will grow to love the Word and to never depart from keeping Torah. As always, feel free to email us at [parshapearls@mtoi.org](mailto:parshapearls@mtoi.org) if you have any questions.

<b>Gem Seeking</b> (The Main Lesson) . . . . .	<b>3</b>
➤ Little Gems Story (Story for Younger Children)	3
➤ Little Gems Story Characters	7
<b>Counting What You Gained</b> (Worksheets) . . . . .	<b>15</b>
➤ Storing Up Treasure in My Heart (Memory Verse)	15
➤ Seeking Treasure (Questions from the Parsha)	17
➤ Word Search	18
➤ Maze	19
<b>Precious Possessions</b> (Arts & Crafts) . . . . .	<b>20</b>
➤ Craft	20
➤ Coloring Page	25
<b>Sweetness of Torah</b> . . . . .	<b>26</b>
➤ Sweet Sounds of Torah (Song Corresponding to the Parsha)	26
➤ Sweet Taste of Torah (Snack Corresponding to the Parsha)	27
<b>Next Week's Treasure Hunt</b> (Looking Ahead to Next Week's Parsha) . . . . .	<b>28</b>



# Gem Seeking

## LITTLE GEMS STORY

### Parent/Teacher Preparation:

Please see the [Instructions for the Little Gems Story](#) on the YMTOI website. This will help you to understand how to prepare for the story.

### Blueprints for the Set-apart Garments

Shalom children! Well, here we are. **(Place Mosheh and mountain on board.)** Mosheh is still up on the mountain listening to Yahweh's instructions about specific things He wants His people to make. Today we are going to talk about some beautiful clothes and other things that He wanted made for a specific group of people to wear at certain times. Let's see what it's all about.

Do you remember that Mosheh had an older brother named Aharon? **(Place Aharon on board.)** Well, Yahweh had chosen Aharon and his sons to be the special people He wanted to wear the special clothes. Yahweh told Mosheh He would bring to Himself Aharon and his 4 sons, Nadab, Abihu, El'azar, and Ithamar to be His priests. **(Place sons on board.)**

But first He wanted some special clothes made for Aharon. I wonder if that was exciting to Mosheh, to have his brother be chosen for something special and to have special clothes made for him. Do you remember the story about Yoseph? His dad had made him special clothes too, but Yoseph's brothers were jealous of Yoseph. **(Place Yoseph on board.)** I don't think Mosheh was the jealous kind. I think he was more the kind of brother that rooted for his brother and sister when they got something special. Do you root for your brother or sister, or even someone else, when they get something special, even if you didn't? I hope so, because that's how Yahweh would want us to behave, NOT in a jealous way. Anyway, like everything else, Yahweh is about to give very specific instructions on how He wants these clothes and accessories made. Let's see how.

**(Remove Yoseph from board.)**

First, Yahweh told Mosheh that He wanted the special clothes for his brother Aharon not only to be beautiful, but also to show people that they were to honor the person wearing them. The clothes were intended to make Aharon stand out from everyone else, as well as his 4 sons **(point to sons)**, who were included in this special purpose. Yahweh was going to make Aharon a priest for Himself. He would serve Yahweh in very specific ways. Doesn't that sound so cool, to be chosen to do a very special job for Yahweh?

And Yahweh chose some other people to be given His wisdom, so they would know how to craft these beautiful things He wanted made. Remember, for years all the Yisra'elites did was build bricks. They didn't have special schools to teach them different jobs, and they didn't really have time to learn on their own because they were always hard at work for Pharaoh.



Yahweh listed all the materials they were to use in making His special things. There was lots of wood, and lots of gold to cover the wood. **(Place acacia wood and gold bars on board.)** And do you remember some of the other materials the people brought? There was fabric of blue, red, and purple, and one called linen that was probably just white.

They also brought stones of different colors and 2 special bigger stones. **(Place fabrics and gems on board.)**

**(Place #1-8 on board as you list and place each article of clothing for priestly garments on board.)**

- 1) The first thing Yahweh wanted them to make was a shoulder garment for Aharon. **(Place shoulder garment on board away from other items.)** He said, "I want you to use all the fabrics together, plus the gold, to make it." **(Point to fabrics and gold bars.)** I imagine the people had no idea exactly what this would look like, but Yahweh gave Mosheh instructions on how to make it, and then chose certain craftsmen who would be filled with a spirit of wisdom to know how to make everything. **(Place man hammering on board.)** He said the shoulder garment was to have 2 shoulder pieces that came together, held in place with a band. All of it was to be made of the same material.

Then came the 2 special stones, called shoham stones, to be marked by an engraver, with the names of all Ya'aqob's sons. Do you know what an engraver is? That's a person who takes special tools and carves very carefully into stone or another hard material. This carving can never be erased or washed off, so he must be very careful, because if he messes up, he will have to start all over again. **(Place engraver on board.)** Remember, there are 12 sons, and this person had to write 6 names on each stone. Yahweh had to show him just how to do it. Wow, I have a hard time writing my name on a small line sometimes! I wonder what size those stones were. Hopefully not too small.

Once the engraving was done, Yahweh wanted the stones to sit in special gold holders called settings. **(Place shoham stones on board next to shoulder garment.)** Have you ever seen a ring or a necklace with a big, pretty gemstone on it? The thing holding the gemstone in place is a setting. But the priest was not going to wear the stones like necklaces. Yahweh wanted them to be put on the shoulders of the shoulder garments.

Every time Aharon came to do his special jobs for Yahweh, he would be carrying the names of the sons of Yisra'el. **(Point to Hebrew on stones.)** Yahweh said they were for a remembrance. Remember how Yahweh gave Ya'aqob his new name, Yisra'el? I am sure Yahweh doesn't forget things, but maybe these stones would help Aharon remember he was representing all those people and honor their name by doing a good job.



- 2) Next, Yahweh wanted a person with special skills to make a breastplate. **(Place breastplate on board.)** It was called the breastplate of right ruling. The person making it had to use the same kinds of materials that were used for the shoulders. This piece would be in the shape of a 9-inch square and twice as thick. There would be 12 of these special gems or stones to be set into the breastplate - a specific stone for each of the sons of Yisra'el, with his name engraved on it. **(Point to stones on breastplate.)** Have you ever seen a ring that has letters or pictures on it that you can actually feel with your finger? Yahweh wanted their names to be written on the stones just like that. The breastplate also had to have rings on it where fine chains would attach the breastplate to each of the shoulder pieces. **(Point to chains on breastplate.)** This is how Aharon would carry the names of the sons of Yisra'el on his chest, close to his heart. Inside the breastplate were placed something called the Urim and Tummim. We don't know today exactly what these looked like, or what they were made of. Someday perhaps Yahweh Himself will explain it to us.
- 3) Next they had to sew a beautiful robe, made from one piece of blue fabric. It had a hole at the top for Aharon to stick his head in. **(Place robe on board.)** And just to make sure that it didn't rip when he put it on or took it off, there was a woven piece around the hole, to protect it. Man, Yahweh thought of everything! Then the shoulder garment was to be put on over the beautiful blue robe.
- Now for the bottom of the robe. All around the hem of it, they had to sew on a pattern of bells and pomegranates: bell, pomegranate, bell, pomegranate, all around the front, back and bottom of the robe. Of course these weren't real pomegranates. They had to make tiny ones out of the blue, purple, and red fabrics. The bells jingled when Aharon walked around, and when he went inside the place where no one else was allowed, everyone would be able to hear the bells as he moved. **(Point to bells and pomegranates.)**
- 4) Next came something special for Aharon's head. **(Place plate of clean gold on board.)** It looked similar to a crown like a king would wear, but it wasn't. Yahweh wanted the phrase "Set-apartness to Yahweh" to be engraved on this gold plate **(point to words on plate)**. They were also told to put some blue cord on each end so that it could be tied to Aharon's head. **(Point to blue cord attached to plate.)** Now, it didn't go straight onto his head like a crown did.
- 5) Aharon had to wear a hat called a turban first **(place turban on board)**; this special crown was tied to the turban and Aharon had to wear this every time he brought the special gifts from the Yisra'elites and presented them to Yahweh.
- 6-8) Now, all these things we just talked about were only for Aharon. Aharon's sons and all the other priests, including Aharon, had to have special garments, all made of linen.



They wore a shirt, some pants, a turban hat, and something called a girdle. **(Place long shirt, girdle, and linen trousers on board next to turban.)** A girdle holds something on. People wear them even today, if they must pick up heavy things while they work. Some of the jobs the priests did required them to lift heavy stuff and the girdle helped them to not have backaches. Ok children don't laugh too hard here, but those pants the priests were to wear **(point to linen trousers)** were like the underwear we wear nowadays. Yahweh wanted them to be longer so just in case their robes moved, the priests would be covered and modest. I'm sure the priests appreciated wearing them. Isn't it thoughtful of Yahweh to think of that too?

Now, Yahweh wanted them to wear this every time they came to His house to work. It set them apart from all the rest of the Yisra'elites. Maybe everyone else wore more colorful clothes, but Yahweh wanted His priests to stand out and look different. Yahweh meant for these white clothes to bring honor to the priests who wore them. You know how a police officer, or the mail carrier, or even a nurse wears a uniform, and you can tell who they work for and what they do just by looking at their clothes? **(Place professionals on board.)** When people saw the priests, they would know exactly what their job was and realize that they were about to go meet with Yahweh. **(Place Aharon in priestly garment and regular priest on board.)**

Well, even though Mosheh is still up there on the mountain getting all the information **(point to Mosheh on mountain)**, isn't it exciting to know that soon Aharon will be given a very special job? I bet Mosheh couldn't wait to tell his brother about all the wonderful things Yahweh had planned for him. But that will have to wait for a little while longer.

Well children, we have come to the end of our story for today. We will see you next week for another exciting Little Gems story!





Aharon in priestly garments



Aharon



Mosheh



Yoseph



Nadab



Abihu

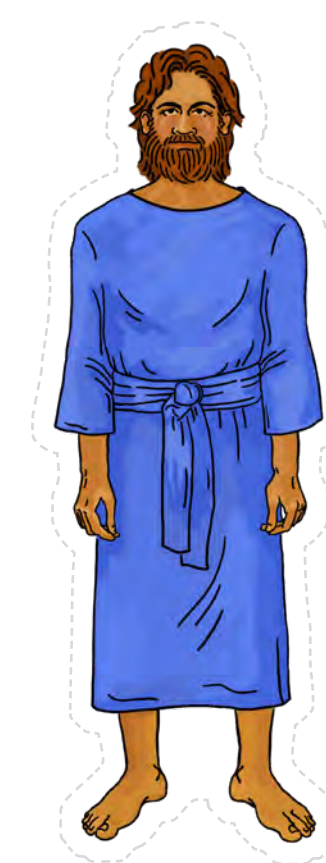

El'azar



Ithamar

Aharon's sons

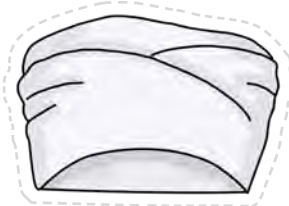

Turban

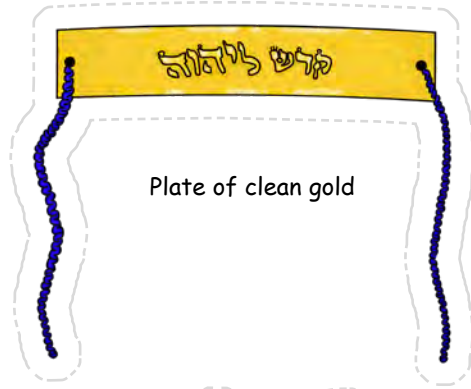
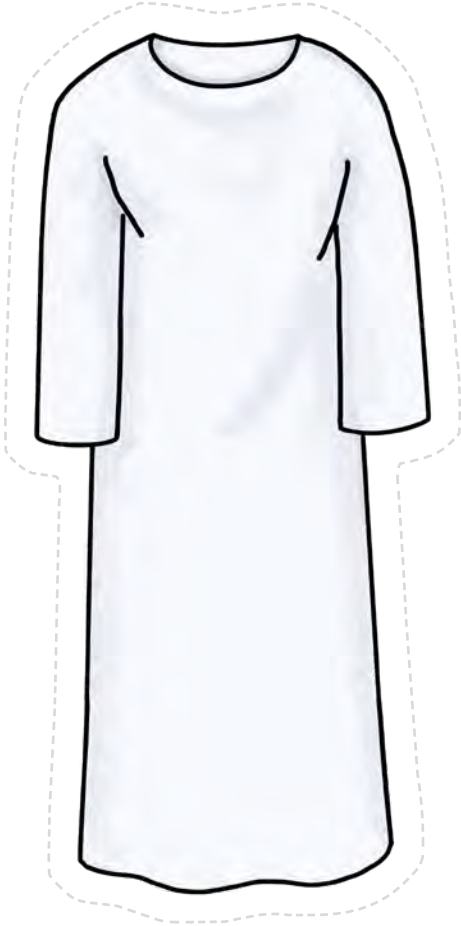
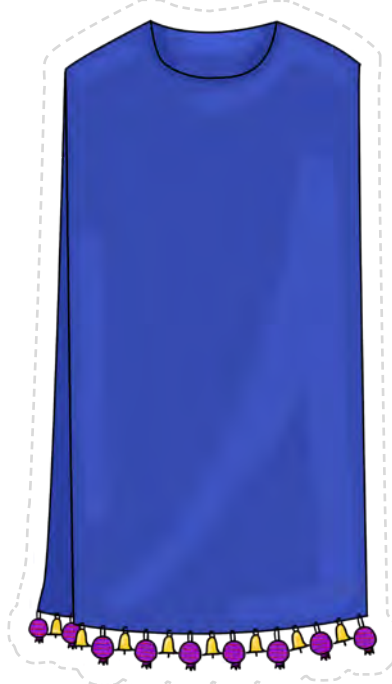

Plate of clean gold



Long shirt



Robe

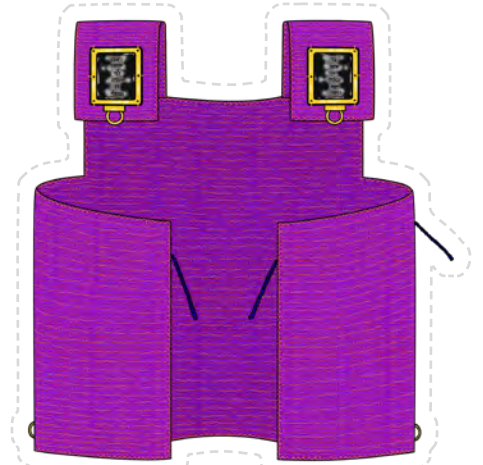

Shoulder garment

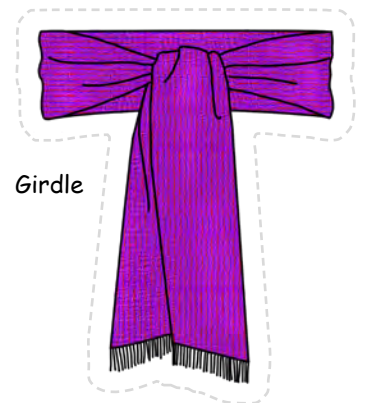

Girdle

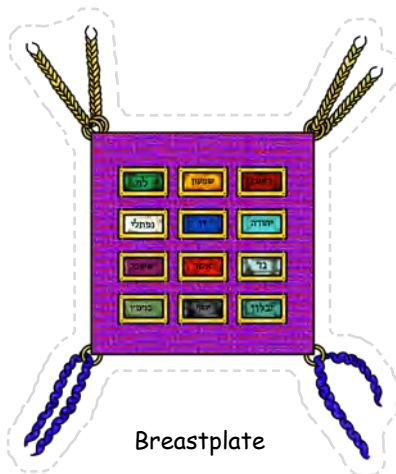

Breastplate



Linen trousers



Shoham stones

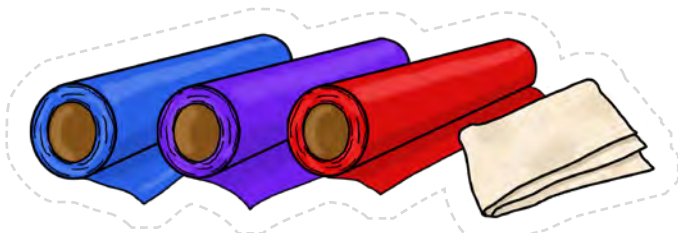

Fabrics and fine linen

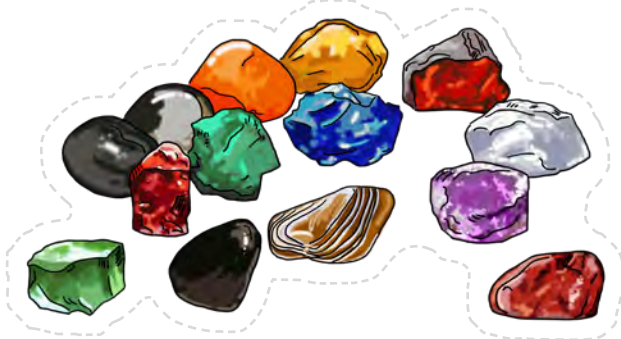

Gems



Gold bars



Acacia wood



Professional police officer



Professional nurse



Professional mail carrier



Man hammering



Engraver



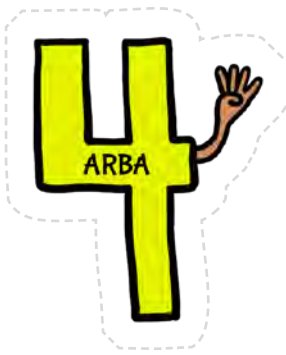

Priest

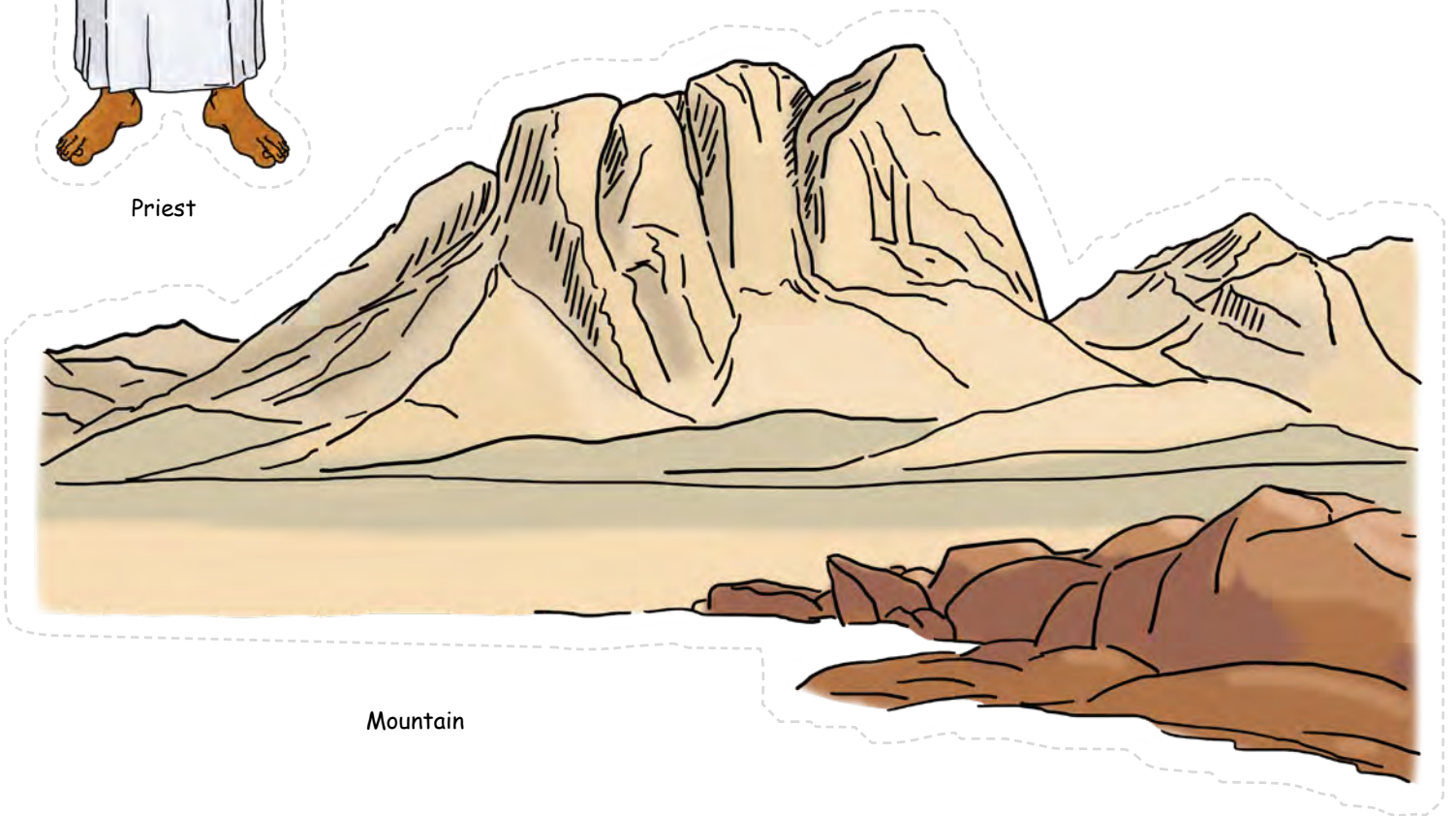

Mountain

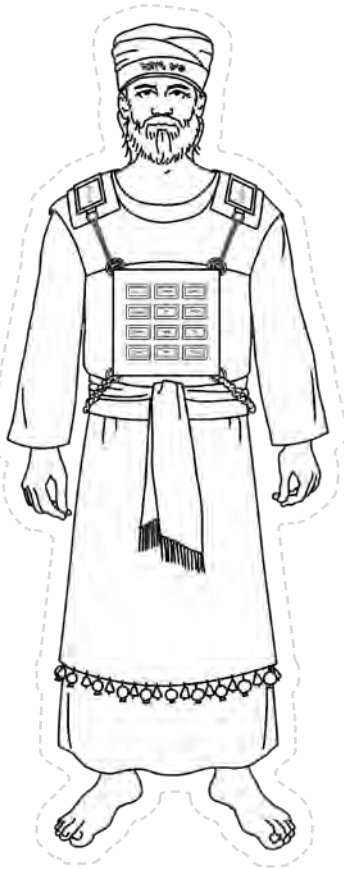

Aharon in priestly garments



Aharon



Mosheh

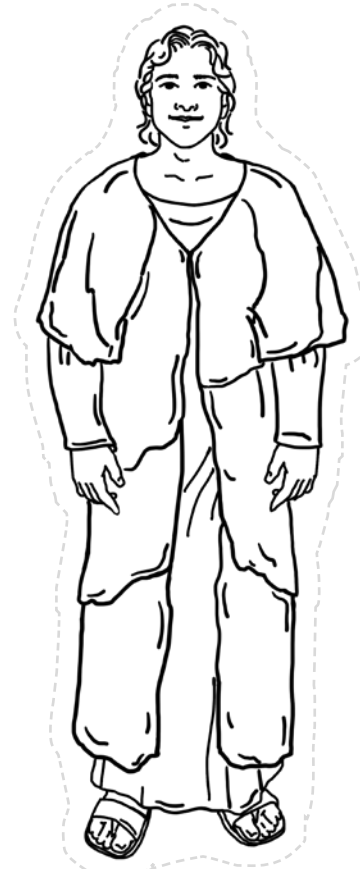

Yoseph



Nadab



Abihu



El'azar



Ithamar

Aharon's sons





Turban

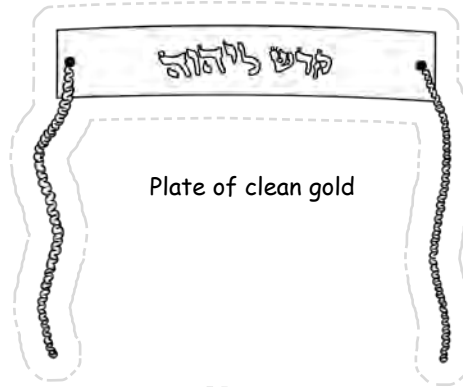
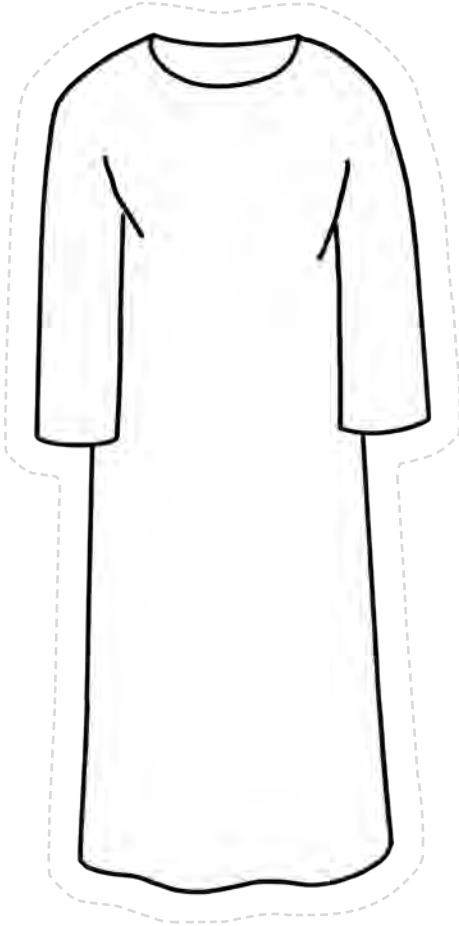
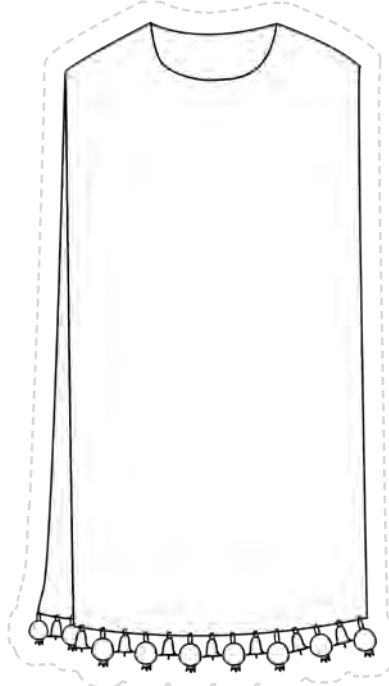

Plate of clean gold



Long shirt



Robe

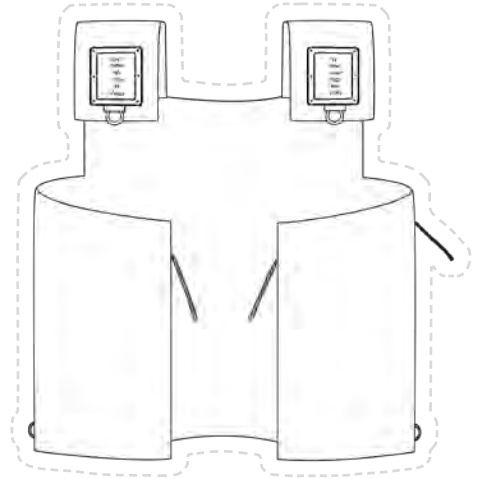

Shoulder garment

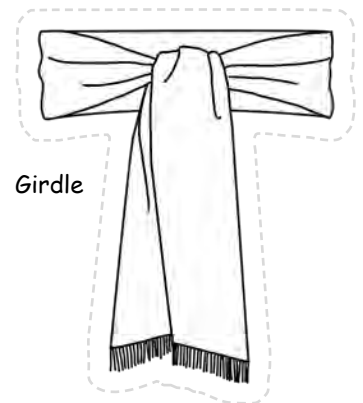

Girdle

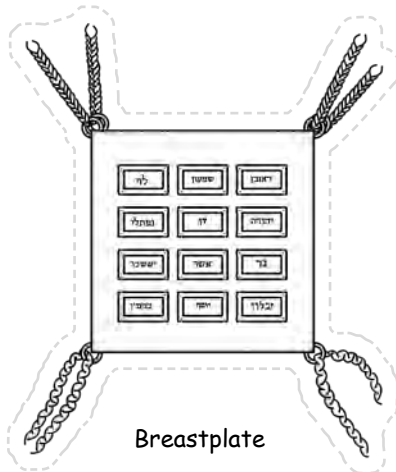

Breastplate

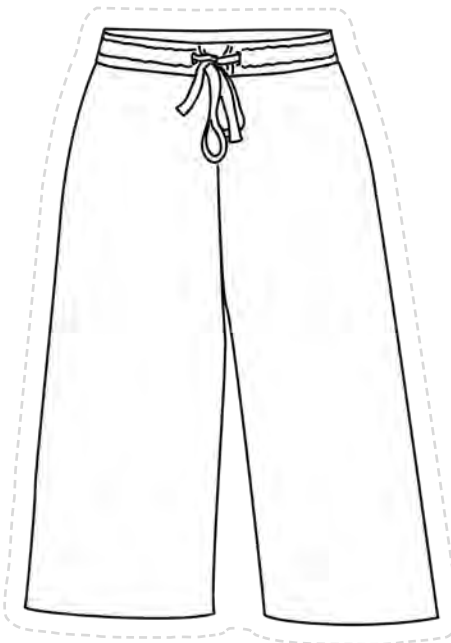

Linen trousers



Shoham stones

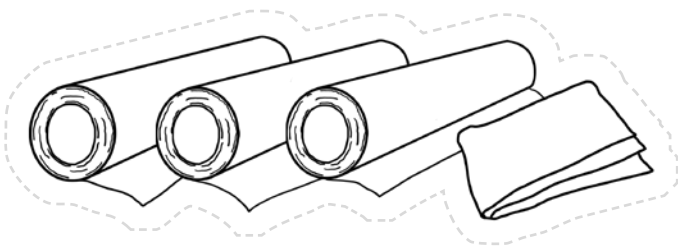

Fabrics and fine linen



Gems

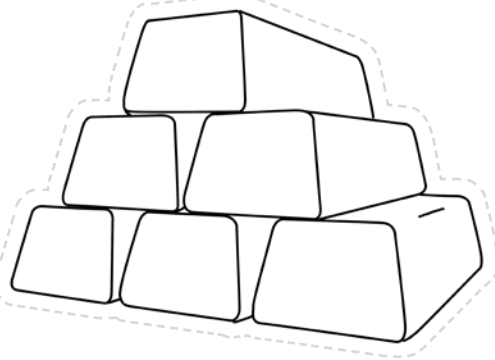

Gold bars

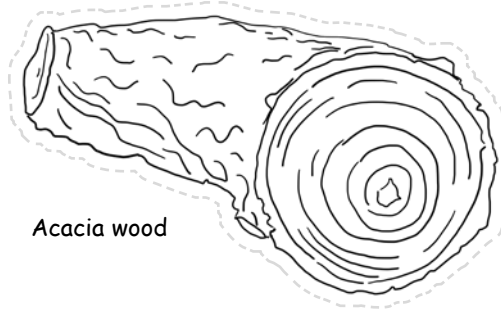

Acacia wood



Professional police officer

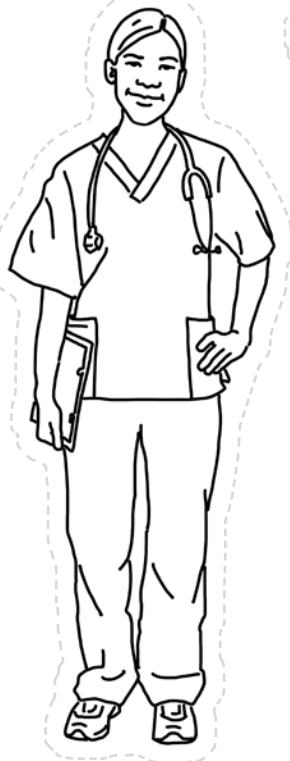

Professional nurse



Professional mail carrier

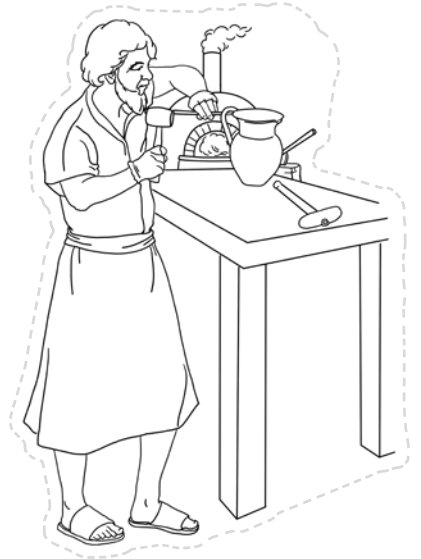

Man hammering



Engraver

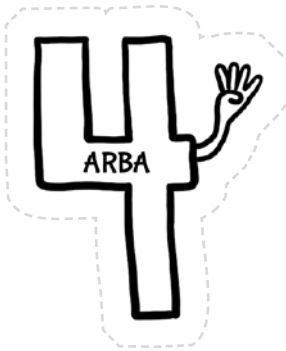

Priest

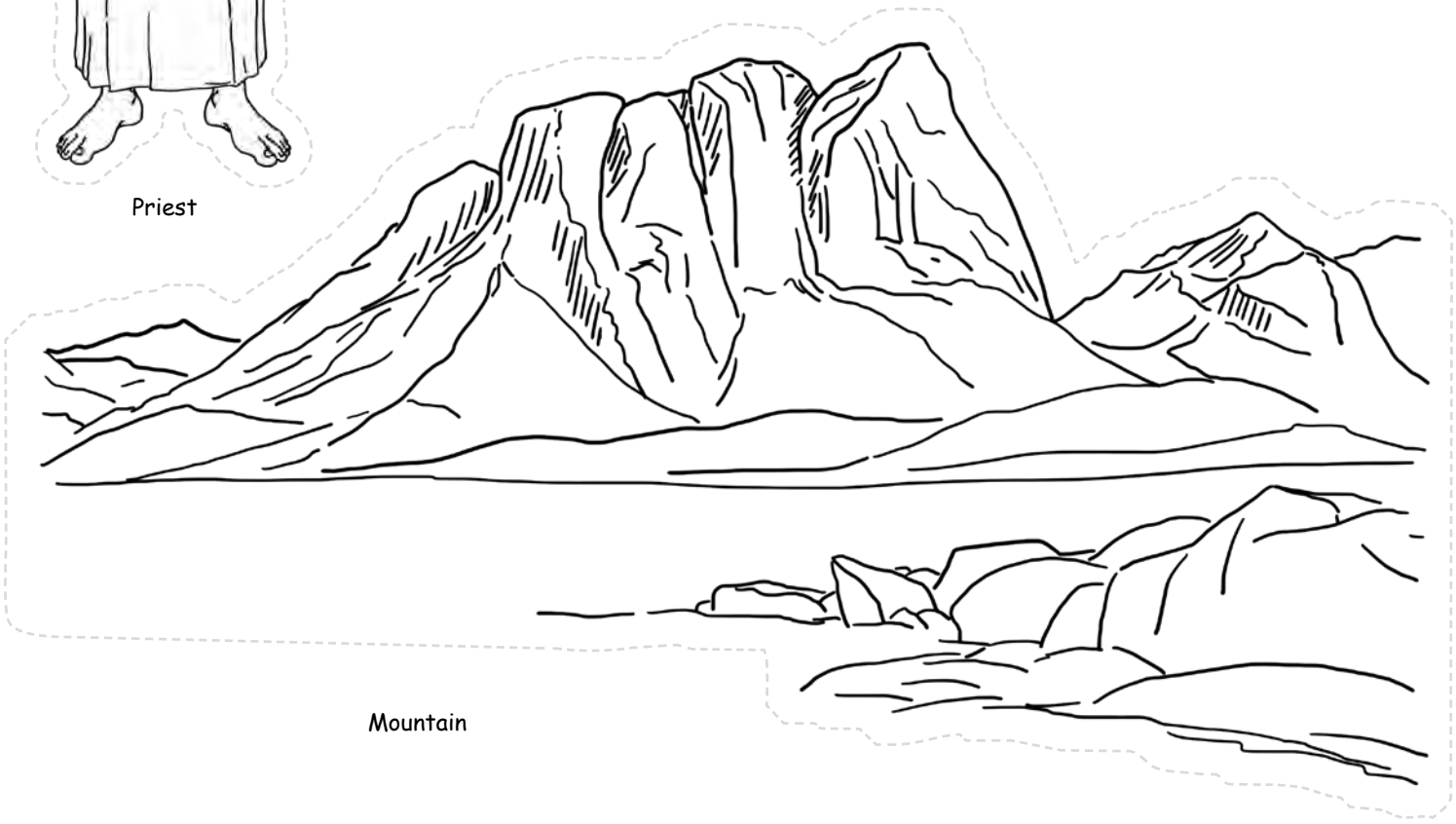

Mountain



# Counting What You Gained

This next section is intended to be reinforcement of the lessons learned during this parsha. Choose the activities that best fit your child.

## STORING UP TREASURE IN MY HEART

The Katan Aleph memory verse for this Torah portion is Exodus 28:2. If they have not already done so, begin to help them to memorize the verse. Be creative and try acting it out, or putting it to music.

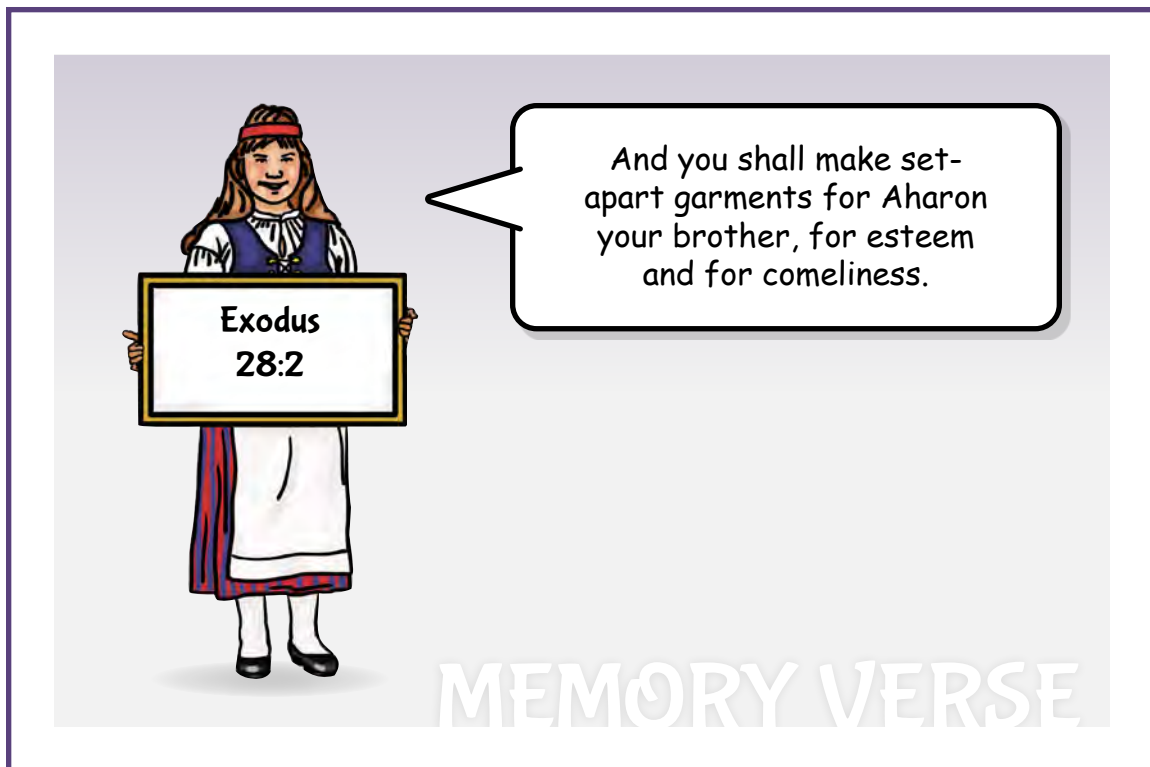



# SEEKING TREASURE

Circle the correct choices.

1. Who did Yahweh want to serve him as priests? (28:1)

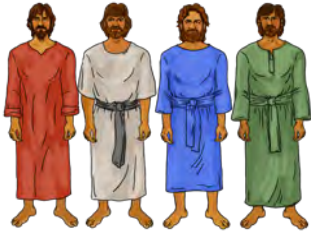

Nadab, Abihu, El'azar and Ithamar



Yoseph



Mosheh



Aharon

2. What colors were used for the shoulder garment, the breastplate and the pomegranates? (28:5-6, 15, 33)

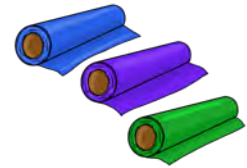
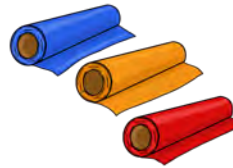
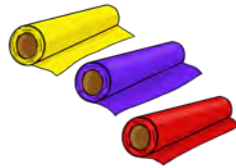
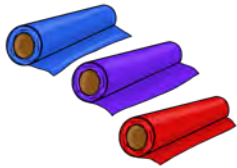

3. Which piece of clothing was blue? (28:31)

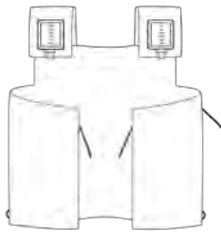

4. What extra piece did Aharon wear on his forehead that his sons did not? (28:36)

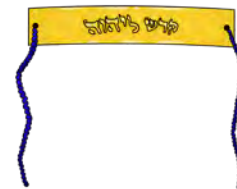
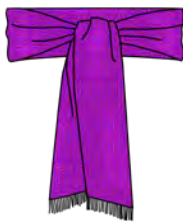

5. Which piece of clothing was made to provide modesty for the priests? (28:42)

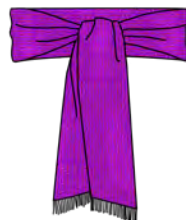

# WORD SEARCH

Search for the hidden words from this week's parsha.

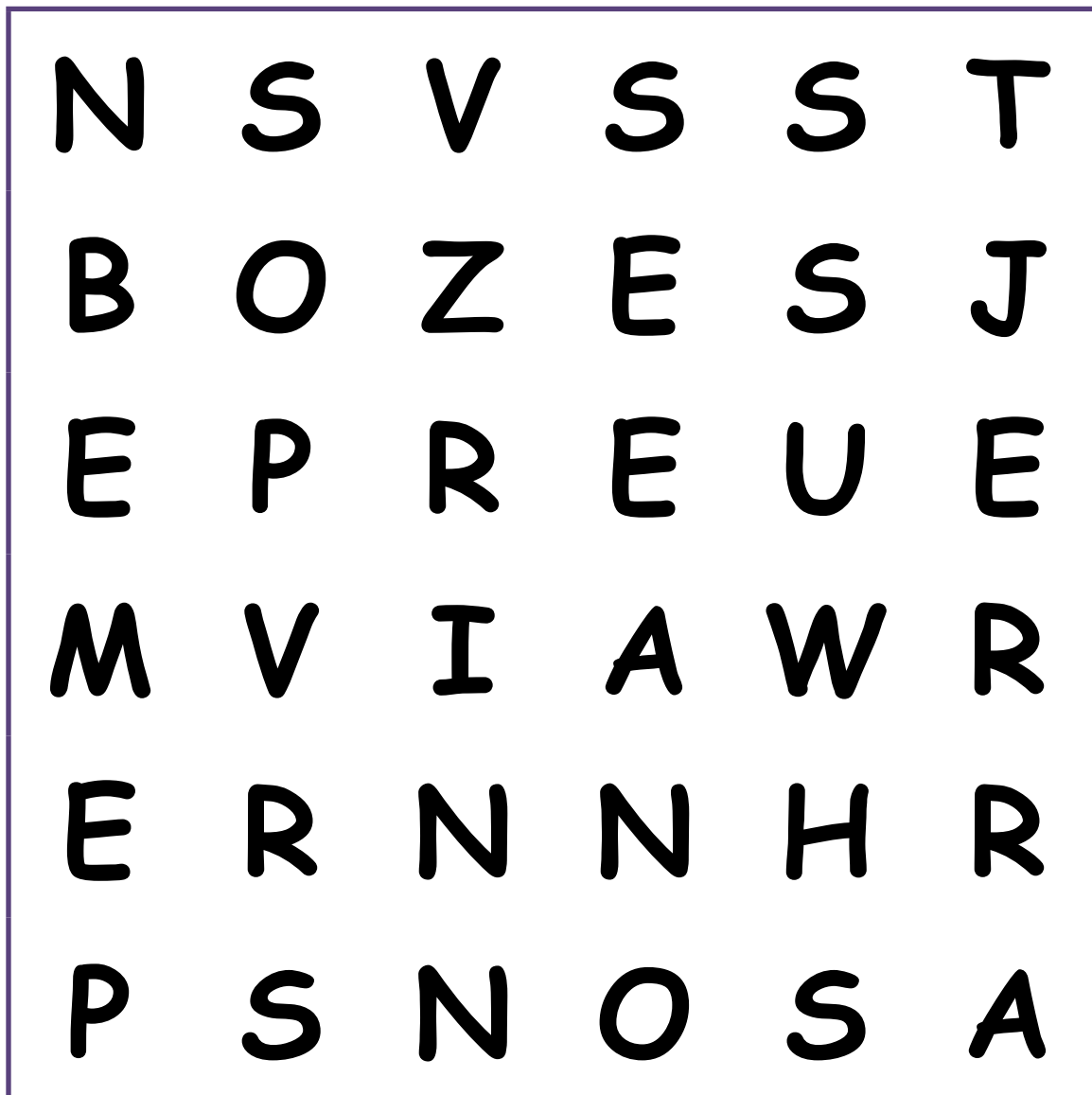

AHARON

SONS

PRIEST

SERVE



# MAZE

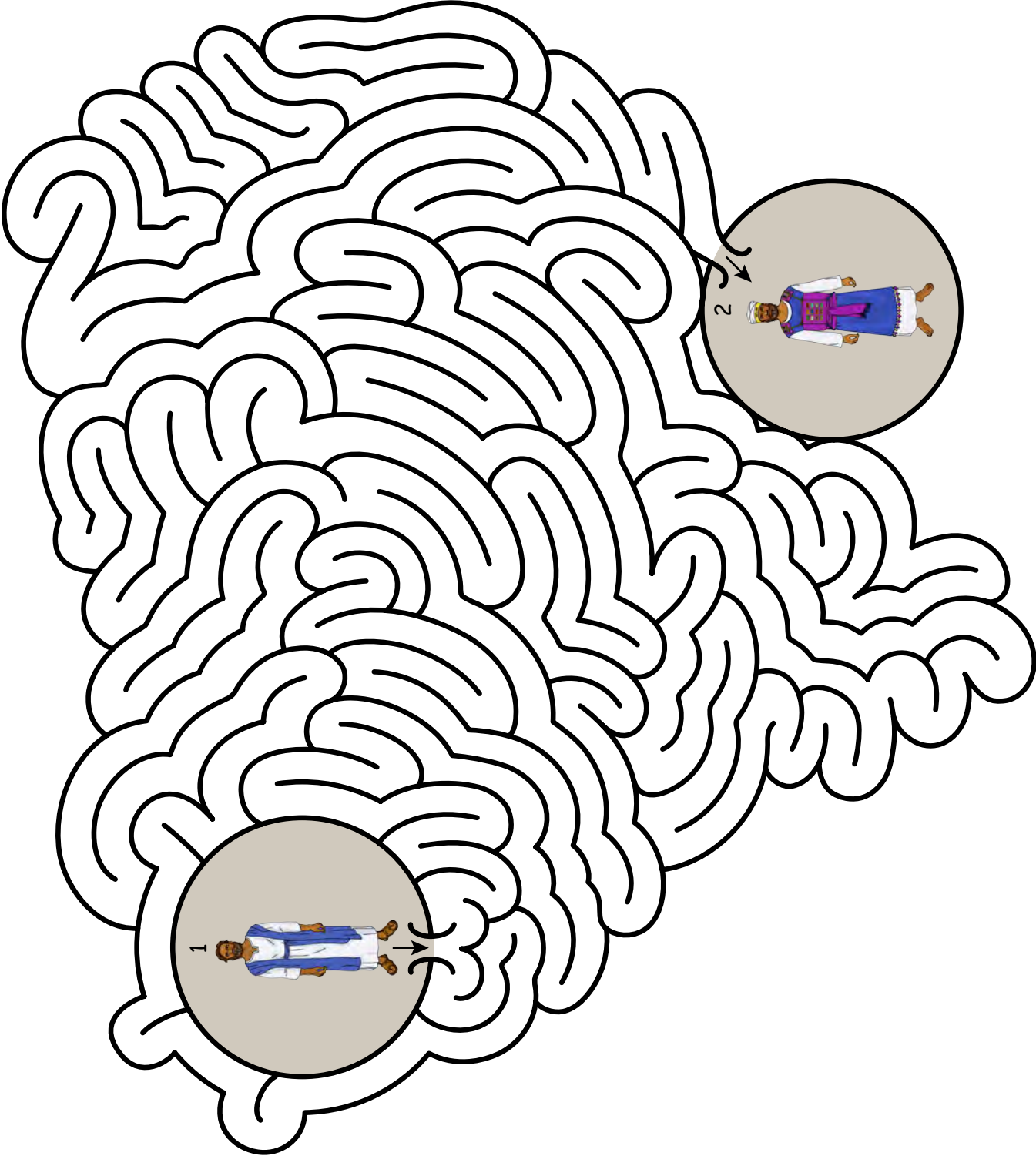

# Precious Possessions

## CRAFT

## High Priest Paper Doll

Exodus 28:4, 36, 40, 42

### Materials:

- Cardstock - white
- Copy paper
- Scissors
- Coloring pencils, crayons or markers
- Craft Templates: A & B (BW) or C & D (color)

#### Parent/Teacher Preparation:

- Print Craft Templates A or C (High Priest) on white cardstock.
- Print Craft Templates B or D (set-apart garments) on copy paper.
- Depending on the skill of the child, you may need to help them cut out the clothing pieces.



### Instructions for the Craft:

- If using BW Templates, color using medium of choice.
- Cut out all Template pieces, being careful not to cut the tabs off. (P1)

#### Dressing Aharon

- Place the embroidered long shirt on Aharon, and fold the 6 tabs onto the back to secure. (P2a, P2b)
- Place the blue robe over the embroidered long shirt, and fold the 4 tabs onto the back to secure. (P3a, P3b)
- Place the breastplate with shoulder garment over the robe, and fold the 4 tabs onto the back to secure. (P4a, P4b)
- Place the turban with the gold plate onto Aharon's head, and fold the 3 tabs onto the back to secure. (P5a, P5b)



P1



P2a



P2b



P3a



P3b



P4a



P4b



P5a



P5b

*You now have a visual representation of the set-apart garments that Aharon was commanded to wear.*

Craft Template A (BW)

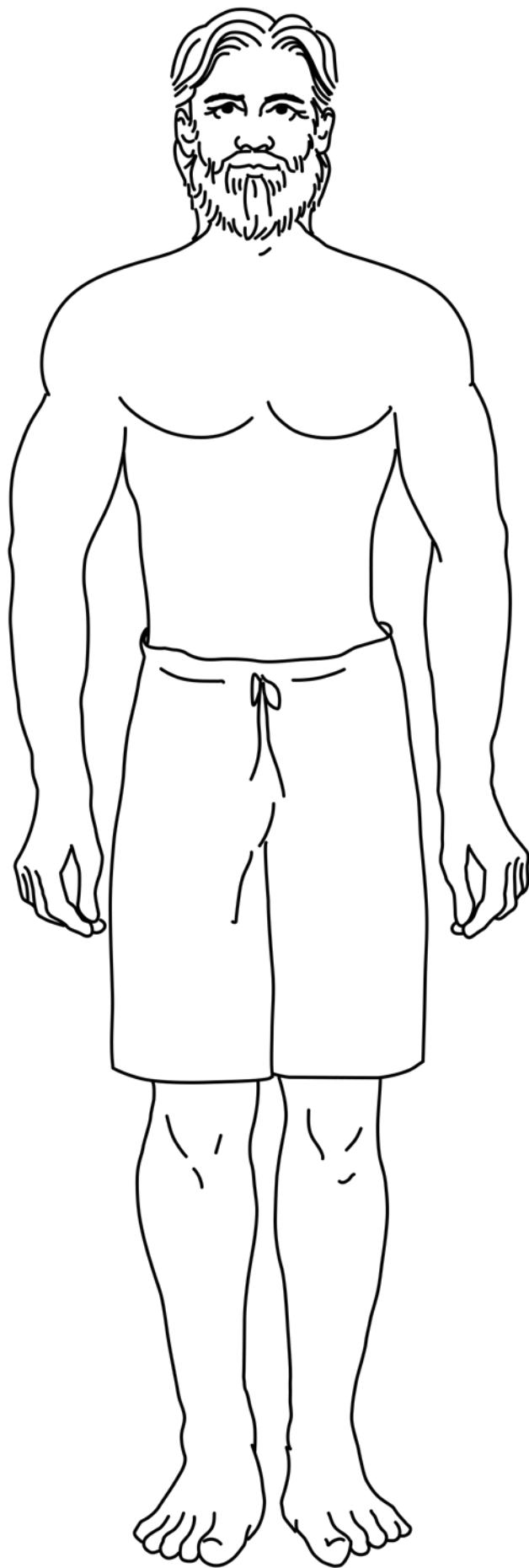

Craft Template B (BW)

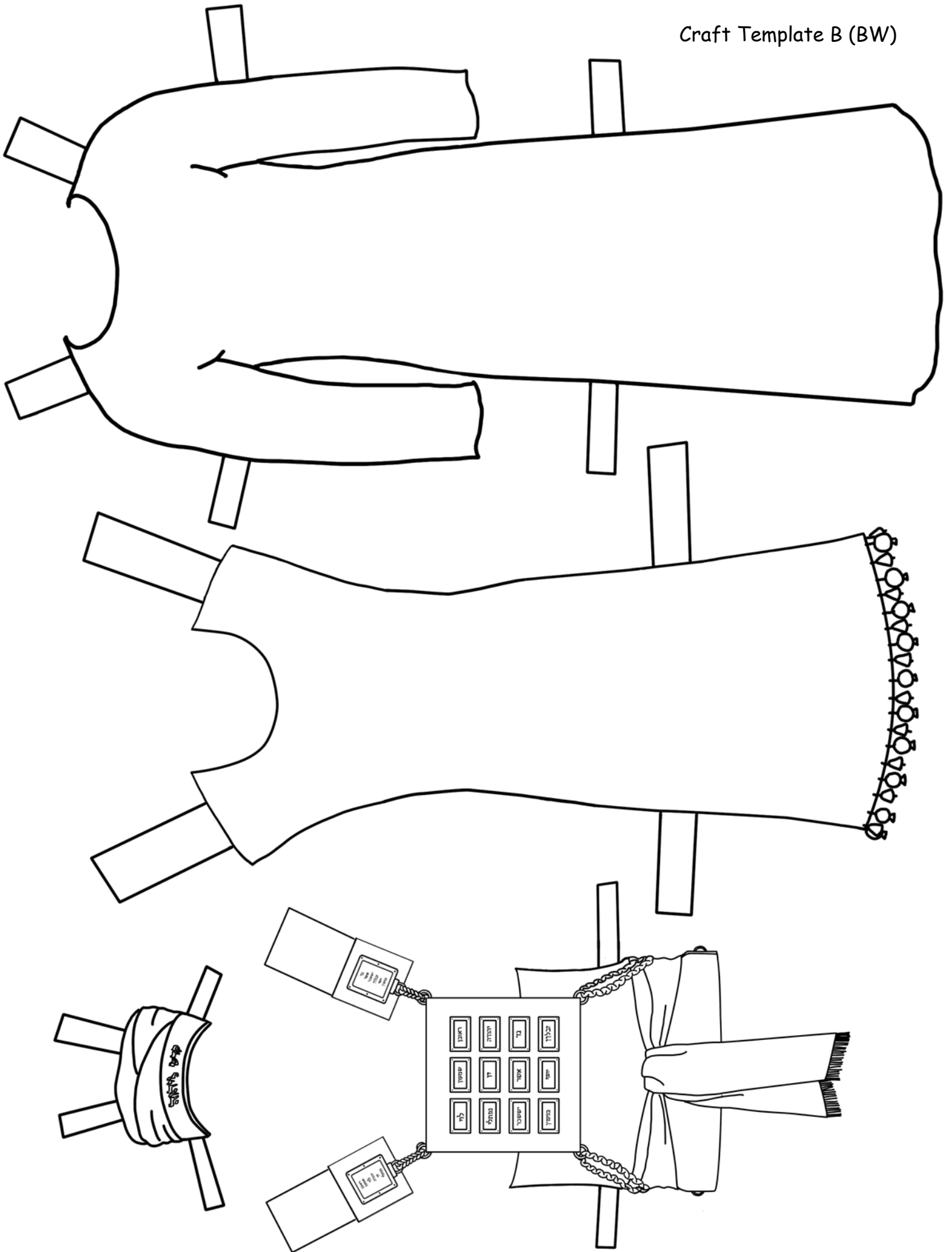

Craft Template C (color)

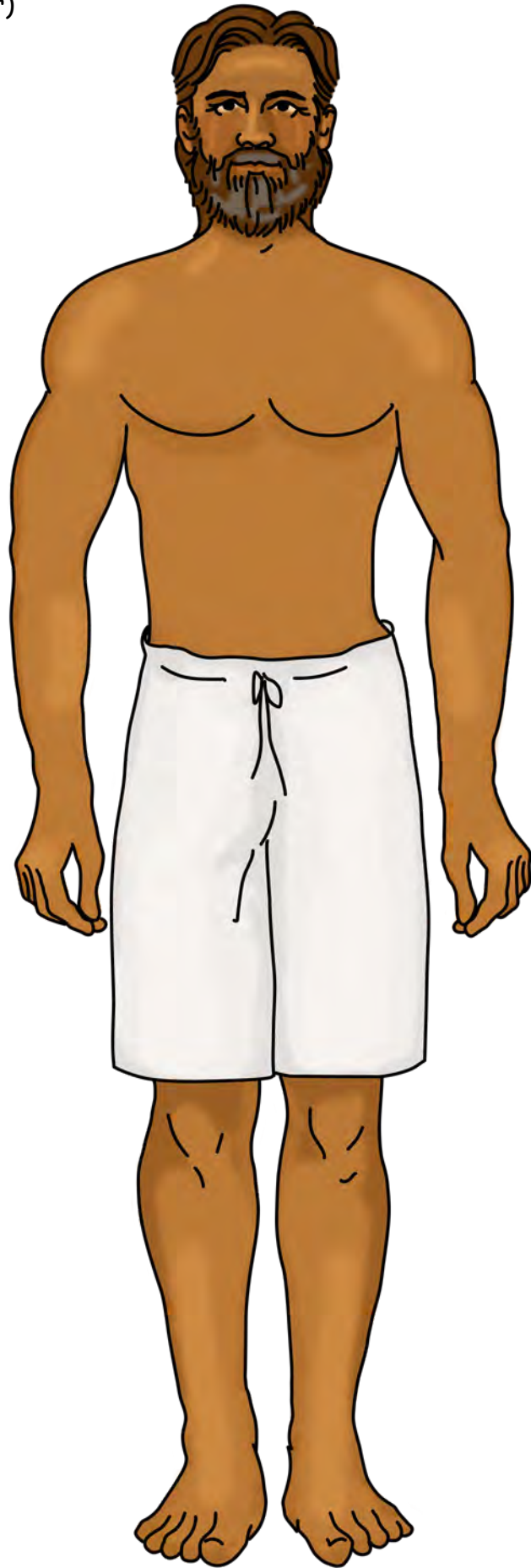

Craft Template D (color)

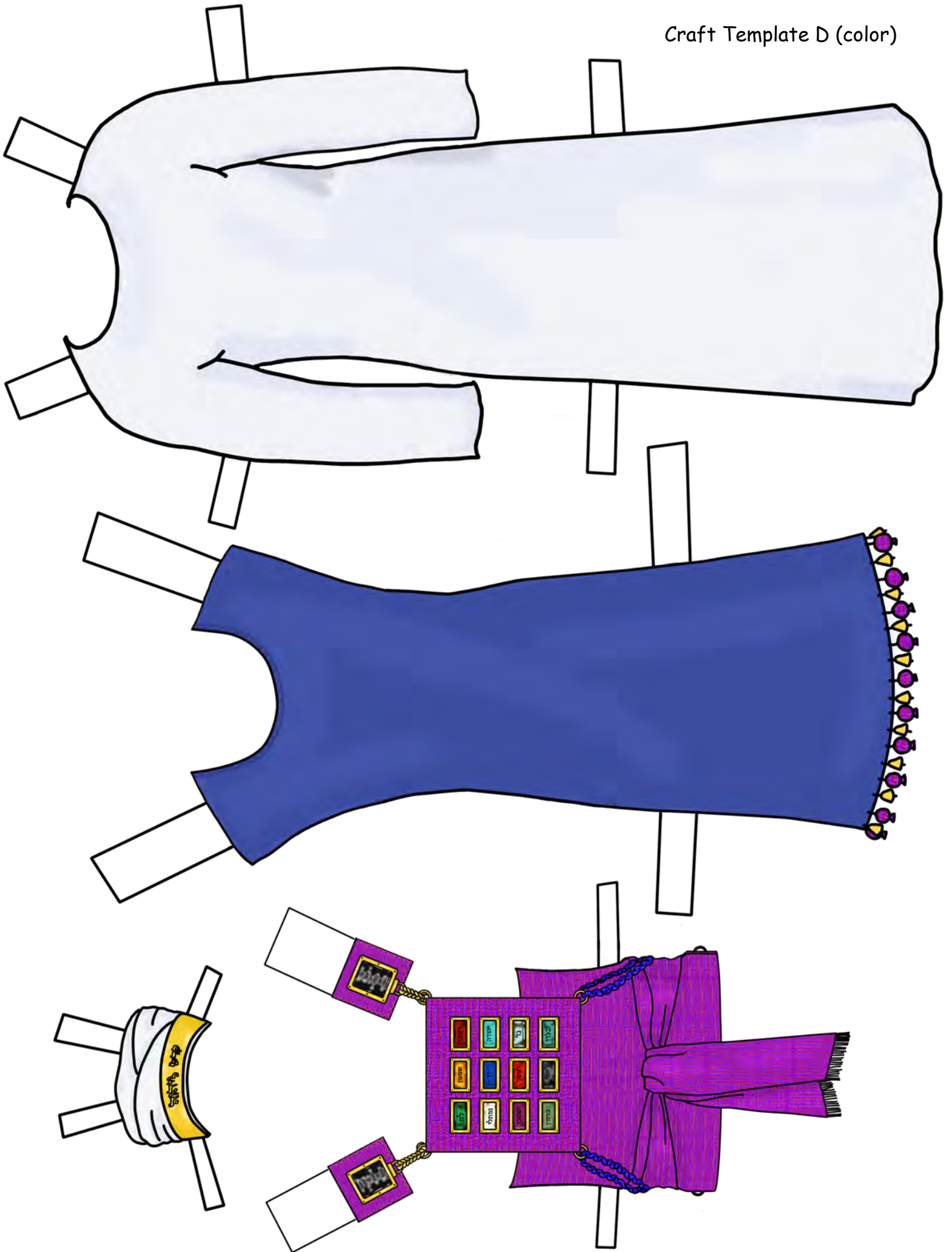

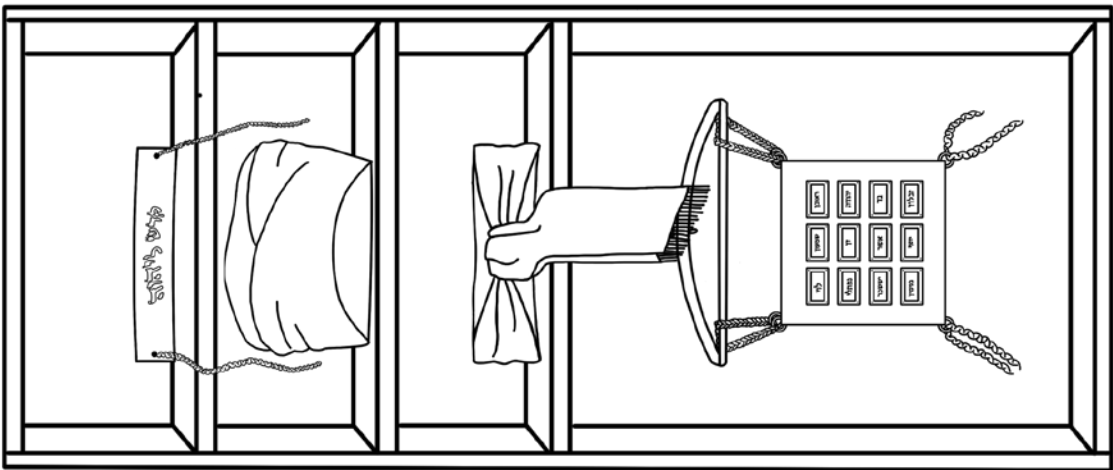
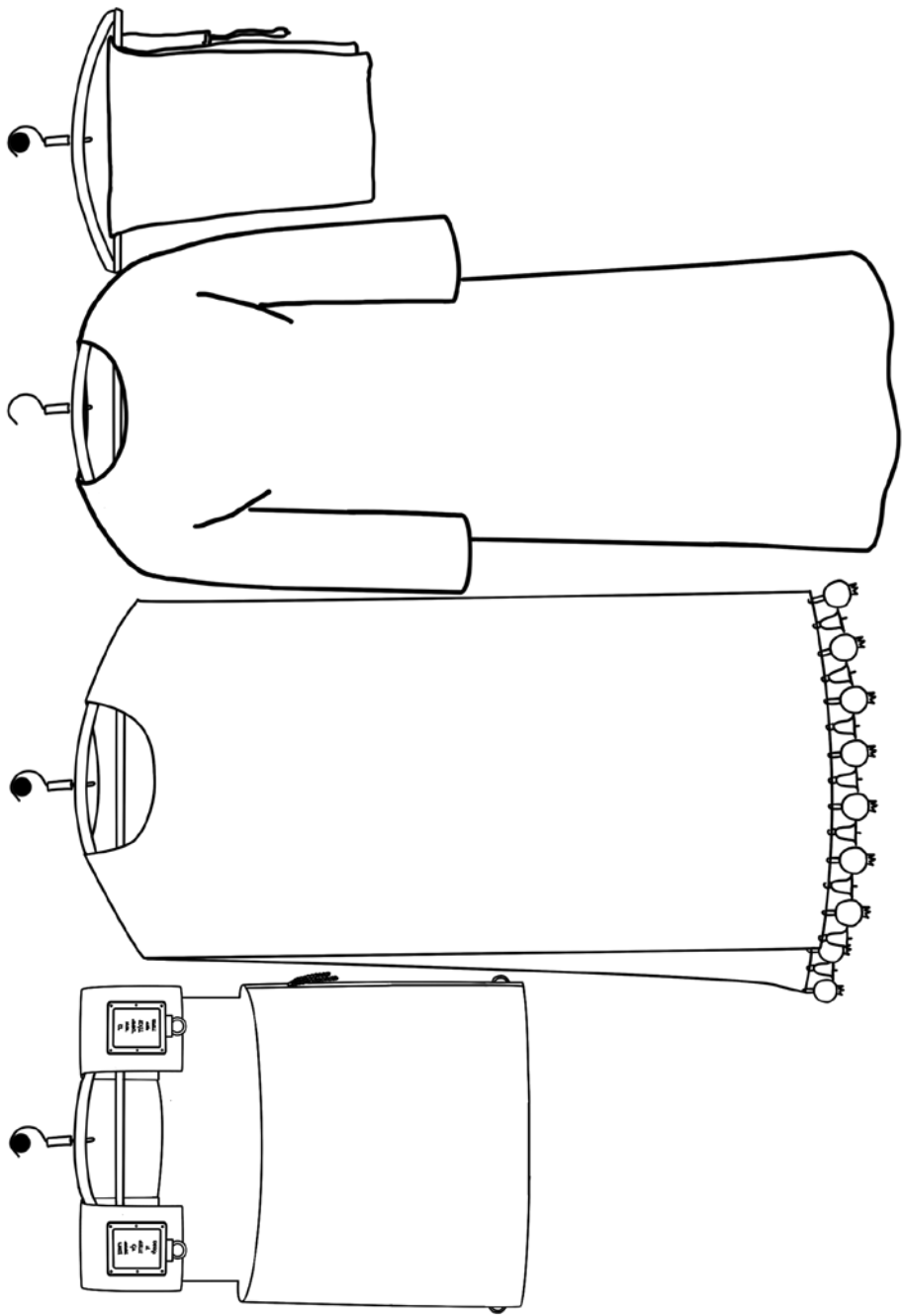

---

# Sweetness of Torah

---

## SWEET SOUNDS OF TORAH

(Sing Praises to His Name)

Here is the link for this song:

[https://www.podomatic.com/podcasts/steveberkson/episodes/2017-03-04T18\\_18\\_18-08\\_00](https://www.podomatic.com/podcasts/steveberkson/episodes/2017-03-04T18_18_18-08_00)

Sing to the tune of "The Bear Went Over the Mountain"

### There are Eight Pieces of Clothing

There are eight pieces of clothing  
There are eight pieces of clothing  
There are eight pieces of clothing  
To set Aharon apart

A turban with a gold plate  
A shoulder garment with two stones  
A long shirt and a sash  
To set Aharon apart

A breastplate with twelve stones  
A robe with bells and pomegranates  
Pants also for modesty  
To set Aharon apart

There are eight pieces of clothing  
There are eight pieces of clothing  
There are eight pieces of clothing  
To set Aharon apart



# SWEET TASTE OF TORAH

This snack relates to this week's parsha. Please take these as suggestions and make necessary changes based on your individual dietary needs.

## Breastplate

(sweet or savory)  
Exodus 28:17-21



### For Sweet

#### Ingredients:

- *Graham cracker* (represents square breastplate)
- Peanut Butter or Marshmallow fluff (sweet shmear)
- Jellybeans, *M & M's*, *Fruit Squishers*, *Fruit Loops* (represents 12 stones)

### For Savory

#### Ingredients:

- Saltine square (represents square breastplate)
- Cream cheese (savory shmear)
- Vegetables (represents 12 stones)

#### Instructions:

Take the cracker, whether sweet (*Graham*) or savory (*Saltine*) and spread the shmear of your choosing on it.

Add any colorful stones and arrange in 4 rows with 3 stones in each row.

# Next Week's Treasure Hunt

## Next Week's Torah Portion

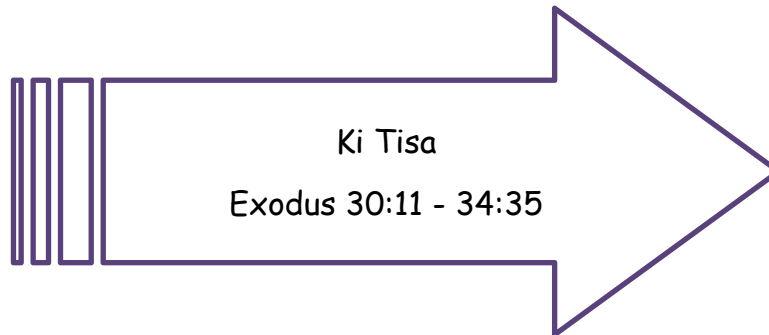

## Suggested Reading Schedule

Monday:	Ex. 30:11 - 31:18	The half-shekel contribution to Yahweh; The bronze basin, anointing oil and incense; Appointing Betsal'el and Oholiab; Sabbath instruction; The 2 tablets of the Witness
Tuesday:	Ex. 32	The golden calf incident
Wednesday:	Ex. 33:1-11	The Exodus from Mt. Sinai; The Tent of Meeting outside the camp
Thursday:	Ex. 33:12-21	Mosheh asks to see Yahweh's esteem
Friday:	Ex. 34	Mosheh cuts the second tablet of stones and sees Yahweh's esteem; The 13 attributes of Yahweh; Instruction to the children of Yisra'el