

# Parsha Pearls

# Purim

"Chag HaPurim Edition"  
The Feast of Lots



Ester 1-10  
Katan Bet/Gadol



---

# Special Feast Edition

---

## INTRODUCTION

### Purim

Purim is a festival commonly observed by and associated with brother Yehudah (Judah). It is celebrated as a joyous and happy festival because it commemorates Yehudah's victory over those who wanted to annihilate them during their exile in the kingdom of Persia, under the reign of King Ahashwerosh (Xerxes).

Purim is celebrated on the 14<sup>th</sup> and 15<sup>th</sup> days of Adar which coincide with the English months of February and/or March. On the 13<sup>th</sup> day of Adar, the Yehudites (Jews) successfully defended themselves from those who wished to destroy them. Their oppressors, led by the Agagite Haman, had cast lots (purim) to determine which day that they should be destroyed. After the Yehudites were victorious over their enemies, they spent the following 2 days in gladness and feasting and for sending portions to one another and gifts to the poor.

Purim is a time to join hands with our brother Yehudah, because of the many times throughout history when enemies rose up seeking to destroy Yahweh's seed. It is the Yehudites who have stood firm against them, and who still carry the torch of Torah truth. For most of their festivals, brother Yehudah sums up the celebration by saying, "They tried to kill us. We survived. Let's eat!"



**Chag Sameach (Happy Feast) from MTOI and YMTOI**

---

# Table of Contents

---

Parsha Pearls is a comprehensive resource that allows for complete customization by the parent. We understand that if you were to strive to accomplish all aspects of each lesson in one day it would be unrealistic and also overload for the child. It is our intention that this be used 'a la carte' so that it suits your specific needs. Our site caters to printing only the pieces you choose.

This page will provide quick links to get to the portion of the document for which you are looking. When you hover over the title a finger will appear. Click on it and you will be taken directly to that page.

If you are new to Parsha Pearls, we have created an [Introduction](#) document outlining how to use our lessons, as well as a [Scriptural Inspiration](#) document, which explains our titles and the Scriptural inspiration for them. We pray that Parsha Pearls blesses your home and that your children will grow to love the Word and to never depart from keeping Torah. As always, feel free to email us at [parshapearls@mtoi.org](mailto:parshapearls@mtoi.org) if you have any questions.

<b>Special Feast Edition</b> . . . . .	<b>2</b>
➤ Introduction	2
➤ Fun Facts About Purim	4
<b>Pearl Seeking</b> (The Main Lesson) . . . . .	<b>5</b>
➤ Parsha Points (Main Lesson Content)	5
➤ Digging Deeper (Thought Provoking Questions)	13
<b>Searching Out Hebrew</b> (Reading & Writing) . . . . .	<b>14</b>
➤ Words	14
➤ Numbers	14
➤ Word Match	15
➤ Flashcards	16
➤ Writing Hebrew	17
<b>Counting What You Gained</b> (Worksheets) . . . . .	<b>18</b>
➤ Storing Up Treasure In My Heart (Memory Verse)	18
➤ Seeking Treasure (Questions from the Parsha)	20
➤ Word Search	23
➤ Crossword Puzzle	25
➤ Maze	27
<b>Precious Possessions</b> (Arts & Crafts) . . . . .	<b>28</b>
➤ Notebook Page	28
➤ Coloring Page	35
» Purim Scene	35
» Purim Text	36
<b>Sweetness of Torah</b> . . . . .	<b>37</b>
➤ Sweet Sounds of Torah (Song Corresponding to the Lesson)	37
➤ Sweet Taste of Torah (Snack Corresponding to the Lesson)	38



# FUN FACTS ABOUT PURIM

## *Hamantashen*

One tradition is to eat a dessert called 'hamantashen'. This is a cookie that is shaped like a triangle, to represent the wicked Haman's hat. It is filled with different types of jellies such as apricot, prune and poppy seed, chocolate, hazelnut spreads, etc. (Ester 9:19, 22).



## *Mishloach Manot/Shalach Manos*

Another enjoyable tradition during Purim is to exchange gift baskets referred to as 'mishloach minot' (sending of portions) filled with tempting treats such as hamantashen (Ester 9:19, 22).

## *Matanot L'evyonim*

As a special mitzvah (kind deed), our brother Yehudah gives charity (money or food) to 2 people during this time so that those who are in need are able to celebrate this feast. This is referred to as 'matanot l'evyonim' in Hebrew which means giving gifts to the poor (Ester 9:22).



## *K'riat Megillah*

A beautiful tradition that is done in every synagogue during the Festival of Purim is listening to the reading of the Book of Ester referred to as the 'megillah' in Hebrew meaning scrolls. As the story is read, whenever the name of evil Haman is said out loud the audience may shake groggers, (special noisemakers made for this day by children) and boo, hiss and stamp feet so as to drown out the sound of his name. When the name of our hero Mordekai is said, there will be loud cheers.



## *Masks/Costumes*

Brother Yehudah has adopted a custom of having children (and even adults) dress up in costumes, to reflect the way Ester 'masked' her identity. This tradition may have started out as a valuable lesson, but later transitioned to looking more like a Jewish Halloween day where children dress up in any type of costume and actually go around and receive candy from the adults. We at MTOI do NOT recommend this approach, but do recognize that having the children dress up in costumes that relate 'specifically' to the characters of the book of Ester can be a great way to enhance the feast.

## *Fasting*

It is also customary to fast on the day before Purim, in order to remember the 3 day fast of Ester before she went in to the king.

# Pearl Seeking

## PARSHA POINTS

This is a special Parsha Pearls lesson designed specifically for the feast of Purim. It is customary to read the story of Ester (Esther) during this festival, because it tells the story of how this festival originated.

\*Because some of the verses contain mature content, we have omitted those particular verses in our Parsha Pearls lesson. Parents may choose to read the verses on their own. Let's read our selected portions from the book of Esther.

### Chapter 1

- King (**melek**) Ahashwerosh reigned over 127 provinces, from India to Kush - 1:1
- In the 3<sup>rd</sup> year of his reign he made a feast (**mishteh**) for all his officials and servants; the power of Persia and Media - 1:3
- He held this feast for 180 days, to show the riches of his esteemed reign and the splendor of his excellent greatness - 1:4
- The king also made an additional feast lasting 7 (**sheva**) days for all the people who were present in the citadel of Shushan, from great to small. It was held in the courtyard of the garden of the king's palace - 1:5
- Ornate tapestries and couches were on display, and wine was served in golden vessels - 1:6-7
- The king decreed that everyone should do according to their pleasure - 1:8
- Queen (**malkah**) Vashti also made a feast for the women in the king's royal palace - 1:9
- At the end of the feast, King Ahashwerosh felt an urge to display the loveliness of his queen to his important banquet guests. He ordered Memukan, Biztha, Harbona, Bigtha, Abagtha, Zethar and Karkas, the 7 eunuchs who attended him, to bring Queen Vashti before the king, wearing her royal crown (**keter**) - 1:10-11
- Queen Vashti refused to come at the command which the king's eunuchs had delivered to her - 1:12
- The king was very angry, and his rage burned within him - 1:12
- The king asked his wise men, "According to law, what is to be done to Queen Vashti, because she did NOT perform the command of King Ahashwerosh, delivered by the eunuchs?" - 1:13-15
- And Memukan answered, "If it pleases the king, let a royal decree go out, and let it be recorded in the laws of the Persians and the Medes, so that it does NOT pass away, that Vashti shall come no more before King Ahashwerosh. And let the king give her royal position to another who is better than she" - 1:16-19
- He also advised the king to issue a decree to be proclaimed throughout all his realm, to cause all wives to give esteem (honor) to their husbands, both great and small - 1:20
- The king heeded the word of Memukan. Letters were sent to all the king's provinces, to each province in its own writing, and to every people in their own language, that each man should be master in his own house and speak in the language of his people - 1:21-22



## Chapter 2

- After these events, the king's servants who attended him said, "Let lovely young maidens be sought for the king, and let the king appoint officers in all the provinces of his reign, and let them gather all the lovely young maidens to the citadel of Shushan, into the women's quarters, under the hand of Hegai the king's eunuch, so that the king might choose a new queen to replace Vashti" - 2:1-4
- And the word pleased the king, and he did so - 2:4
- At this time, there was a certain man in Shushan, a Yehudite whose name was Morde<sup>k</sup>ai (Mordecai), a Binyamite (Benjamite), who had been exiled from Yerushalayim (Jerusalem). He was raising Hadassah, that is Ester, his uncle's daughter, for her father and mother had died - 2:5-7
- Ester was lovely and of good appearance, and became one of the choice maidens who was taken to the king's palace and placed into the hand of Hegai, guardian of the women - 2:7-8
- Hegai gave Ester (2:9):



- kindness
- special preparations and portions
- 7 choice female servants
- the best place in the house of the women



- In keeping with her uncle's command, Ester did NOT disclose or make known her people or her relatives to anyone - 2:10
- Every day Morde<sup>k</sup>ai walked in the courtyard, to learn of Ester's welfare and what was done to her - 2:11
- Ester and all the young women spent 12 (**shtem esre**) months getting ready to be presented to the king. Their treatment included (2:11-12):

- 6 (**shesh**) months with oil of myrrh
- 6 months with perfumes and the preparations of women



- When it was Ester's turn to be taken to King Ahashwerosh, into his royal palace, the king loved Ester more than all the women, and she found favor and kindness in his eyes more than all the maidens. And he set the royal crown upon her head and made her queen instead of Vashti - 2:16-17
- The king made a great feast, the 'Feast of Ester', for all his officials and servants. And he proclaimed a release in the provinces and gave gifts according to the means of a king - 2:18



- Ester still obeyed the command of Morde<sup>k</sup>ai and did NOT make known her relatives or her people to anyone - 2:20
- Morde<sup>k</sup>ai, who sat within the king's gate, learned that Bigthan and Teresh, 2 (**shtayim**) eunuchs who served as the king's doorkeepers, became angry at King Ahashwerosh and planned to lay hands on him. Morde<sup>k</sup>ai then revealed the matter to his cousin, Queen Ester - 2:21-22
- After the matter was searched and confirmed, both eunuchs were impaled on a stake. And it was written in the book of the annals in the presence of the king - 2:23



## Chapter 3

- Following these events, King Ahashwerosh promoted Haman, the Agagite, and exalted him and seated him higher than all the princes with him - 3:1
- All the king's servants who were in his gate bowed and did obeisance to Haman, as the king had commanded. But Mordekai refused to bow or do obeisance to Haman - 3:2
- When Haman saw that Mordekai the Yehudite did NOT bow or do obeisance in his presence, Haman became very angry - 3:5
- Haman then sought to destroy all the people of Mordekai, the Yehudim who were throughout all the reign of Ahashwerosh - 3:6
- In the first month, which is the month of Nisan, in the 12<sup>th</sup> year of King Ahashwerosh, someone cast Pur - that is, the lot - before Haman from day to day, and from month to month, until it fell on the 12<sup>th</sup> month, which is the month of Adar - 3:7
- Haman then told King Ahashwerosh (3:8-9):
  - "There is a certain people scattered and dispersed among the people in all the provinces of your reign, whose laws are different from all people"
  - "They do NOT do the king's laws"
  - "It is NOT in the king's interest to let them remain"
  - "If it pleases the king, let a decree be written to destroy them"
  - "Let me pay 10,000 talents of silver into the hands of those who do the work, to bring it into the king's treasuries"
- The king took his signet ring from his hand and gave it to Haman, and the king said to Haman, "The silver and the people are given to you, to do with them as seems good to you" - 3:10-11
- The king's scribes were called on the 13<sup>th</sup> day of the first month to write a decree according to all that Haman commanded and it was sealed with the king's signet ring - 3:12
- Letters were sent by the runners into all the king's provinces, to cut off, to slay, and to destroy all the Yehudim, both young and old, little children and women, in one day, on the 13<sup>th</sup> day of the 12<sup>th</sup> month, which is the month of Adar, and to plunder their possessions - 3:13
- As soon as the decree had been given out in the citadel of Shushan, the king and Haman then sat down to drink, but the city of Shushan was in confusion - 3:15



## Chapter 4

- When Mordekai learned of all that had been done, he tore his garments, put on sackcloth and ashes, and went out into the midst of the city, crying out with a loud and bitter cry - 4:1
- Among the Yehudim, there was great mourning and fasting, with much weeping and wailing. And many lay in sackcloth and ashes - 4:3
- When Ester's young women and eunuchs came and told her, the queen was deeply pained. She sent garments for Mordekai to wear, to take away his sackcloth from him, but he refused - 4:4



- Ester called Hathak, one of the king's eunuchs appointed to attend her, and she commanded him to find out what all Mordekai's distress was about - 4:5

- Mordekai told Hathak (4:7-8):

- all about the silver that Haman promised to pay into the king's treasuries to destroy the Yehudim
- told him to show Ester a copy of the written decree to destroy them, and explain it to her
- to command Ester to go in to the king to make supplication to him, and plead before him for her people



- Ester replied to Mordekai (4:10-11):

- "Everyone knows that any man or woman who goes into the inner court to the king, who has NOT been called, he has but one law: to be put to death, except the one to whom the king holds out the golden scepter, only then may they live"
- "I have NOT been called to come in to the king these 30 (shloshim) days"

- Mordekai then sent these words to Ester (4:13-14):

- "Do NOT think within yourself to escape in the king's palace any more than all the other Yehudim"
- "If you keep entirely silent at this time, relief and deliverance shall arise for the Yehudim from another place, while you and your father's house perish"
- "And who knows whether you have come to the reign for such a time as this"



- Ester responded to Mordekai (4:15-16):

- "Go, gather all the Yehudim who are present in Shushan, and fast for me"
- "Do NOT eat or drink for 3 (shalosh) days, night or day"
- "I too, and my young women shall fast in the same way"
- "Then I shall go to the king, which is against the law"
- "If I shall perish, I shall perish!"



- Mordekai then went away and did according to all that Ester commanded him - 4:17

## Chapter 5

- On the 3<sup>rd</sup> day, Ester put on royal apparel and approached the king. When the king saw Queen Ester standing in the court, she found favor in his eyes, and the king held out to Ester the golden scepter which was in his hand. And Ester went near and touched the top of the scepter - 5:1-2
- The king said to her, "What is it, Queen Ester, and what is your request? Up to half my reign, and it is given to you!" - 5:3
- Ester answered, "If it pleases the king, let the king and Haman come today to the feast which I have prepared for him" - 5:4
- At the feast, the king asked Ester, "What is your petition? And it is given you. And what is your request? Up to half my reign, and it is done!" - 5:6



- Ester answered him, requesting that if she had found favor in the eyes of the king, that he and Haman come to another feast which she would prepare for the next day - 5:7-8
- Haman went out that day rejoicing and with a glad heart. But when Haman saw Mordeḳai in the king's gate, and that he did NOT stand or tremble before him, he was filled with wrath against Mordeḳai. Even so, Haman held back his emotions - 5:9-10
- When Haman came to his house, he sent and called for his friends and Zeresh his wife and spoke to them about the esteem of his wealth, and his many sons, and all in which the king had promoted him, and how he had exalted him above the officials and servants of the king - 5:10-11
- Haman bragged to them that no one but himself was to come with the king to the feast which the queen had prepared, and that he was invited tomorrow also - 5:12
- Remembering Mordeḳai, he told his family, "All this does not suit me, as long as I see Mordeḳai the Yehudite sitting at the king's gate" - 5:13
- Haman's wife Zeresh and all his friends said to him (5:14):
  - "Let a wooden structure be made, 50 (**chamishim**) cubits high"
  - "In the morning, speak to the king, asking that Mordeḳai be impaled on it"
  - "Go with the king to the feast, rejoicing"
- And the word pleased Haman, and he had the wooden structure made - 5:14



## Chapter 6

- That very night the king had trouble sleeping, and called for the book of the records of the annals to be read to him - 6:1
- When it was read how Mordeḳai had saved the king from being assassinated, the king inquired if anything had been done to honor Mordeḳai. His servants informed him that nothing had been done - 6:2-3
- At the moment, Haman entered, intending to speak to the king about impaling Mordeḳai. But before Haman could speak, the king asked him, "What is to be done for the man whom the king delights to value?" - 6:4-6
- Haman assumed that he himself must be the one whom the king wished to honor, so he told the king (6:4-9):
  - "For the man whom the king delights to value, let a royal robe be brought which the king has worn, and let this robe be given into the hand of one of the king's most noble princes. Let them dress the man whom the king delights to value."
  - "Let a horse on which the king has ridden, one with a royal crest placed on its head, be given into the hand of one of the king's most noble princes, to lead the man on horseback through the city square."
  - "Proclaim before him, 'This is done to the man whom the king delights to value!'"
- The king told Haman to hurry and do all this to Mordeḳai the Yehudite who sat in the king's gate, and NOT to fail in accomplishing what he himself had just spoken - 6:10
- Haman fulfilled the task that the king commanded, then went home mourning and covering his head - 6:11-12



- Haman's family, friends and wise men saw the handwriting on the wall and warned him that he would NOT prevail against Mordeḳai, because he was from the seed of the Yehudim. Instead, Haman would be the one to fall - 6:13
- As they were speaking, the king's eunuchs showed up to escort Haman to the 2<sup>nd</sup> feast which Ester had prepared - 6:14

## Chapter 7

- At the feast, the king again asked Ester again, "What is your petition, Queen Ester? And it is given to you. And what is your request? Up to half my reign, and it is done!" - 7:2
- Queen Ester answered and said, "If I have found favor in your eyes, O king, and if it pleases the king, let my life be given me at my petition, and my people at my request. For we have been sold, my people and I, to be cut off, to be slain, and to be destroyed. And if we had been sold as male and female slaves, I would have kept silent, although the adversary could NOT make up for the king's loss" - 7:3-4
- King Ahashwerosh asked Queen Ester, "Who is he, and where is he, whose heart is set to do so?" - 7:5
- Ester told the king that the adversary and enemy was evil Haman -7:6
- Then Haman was afraid before the king and queen - 7:6
- The king was very angry and removed himself to the palace garden - 7:7
- Haman remained behind and pleaded for his life, for he saw that evil had been decided against him by the king - 7:7-8
- The king returned from the garden just as Haman was falling on the couch where Ester sat, pleading for his life. The king demanded of Haman, "Will you disrespect the queen while I am in the house?" - 7:8
- The king's eunuch, Harbonah, then informed the king that Haman had constructed a wooden structure 50 cubits high on which to execute Mordeḳai, and that it was standing at the house of Haman - 7:9
- The king immediately commanded that Haman be impaled on the wooden structure prepared for Mordeḳai. After Haman's death, the king's wrath subsided - 7:10



## Chapter 8

- After this King Ahashwerosh gave to Queen Ester the house of Haman, the adversary of the Yehudim - 8:1
- Then the king took off his signet ring, which he had taken back from Haman, and gave it to Mordeḳai. And Ester appointed Mordeḳai over the house of Haman - 8:2
- Ester then approached the king a 2<sup>nd</sup> time, falling down at his feet and begging him with tears to put an end to the evil of Haman the Agagite, and his plot which he had plotted against the Yehudim - 8:3
- As before, the king held out the golden scepter toward Ester. And Ester arose and stood before the king, and said (8:4-6):
  - "If it pleases the king, and if I have found favor in his sight and the matter is right before the king and I am pleasing in his eyes, let it be written to bring back the letters, the plot by Haman, the Agagite, which he wrote to destroy the Yehudim who are in all the king's provinces."



- "How could I bear to see the evil coming to my people?"
- "How could I bear to see the destruction of my relatives?"
- King Ahashwerosh told Queen Ester and Morde<sup>k</sup>ai the Yehudite to write a decree in favor of the Yehudim and seal it with the king's signet ring, as a letter which was written in the king's name and sealed with the king's signet ring, which no one could reverse - 8:8
- Then the king's scribes were called in, in the 3<sup>rd</sup> month, which is the month of Siwan, on the 23<sup>rd</sup> day. And it was written, according to all that Morde<sup>k</sup>ai commanded to the Yehudim, and to the viceroys, and the governors, and the princes of the provinces from India to Kush, 127 provinces, to every province in its own writing, to every people in their own language, and to the Yehudim in their own writing, and in their own language - 8:9
- Morde<sup>k</sup>ai wrote in the name of King Ahashwerosh, and sealed it with the king's signet ring, and sent letters by runners on horseback saying (8:10-12):
  - "The king has granted to the Yehudim who were in every city to be assembled and stand for their lives."
  - "Cut off, slay, and destroy all the power of the people or province that would distress them."
  - "Plunder their possessions on the 13<sup>th</sup> day of the 12<sup>th</sup> month, which is the month of Adar."
- This writing was made law in every province and announced to all the peoples, so that the Yehudim would be ready on that day to be avenged on their enemies - 8:13
- Morde<sup>k</sup>ai went out from the presence of the king wearing royal garments of blue and white, with a great crown of gold and a garment of fine linen and purple. And the city of Shushan rejoiced and was glad - 8:15
- And in every province and in every city where the king's command and decree came, the Yehudim had joy, light, and gladness, a feast and a good day - 8:16-17
- And many of the people of the land were becoming Yehudim, for the fear of the Yehudim had fallen upon them - 8:17



## Chapter 9

- In the 12<sup>th</sup> month (Adar), on the 13<sup>th</sup> day, throughout all the provinces, the Yehudim and all the officials, viceroys and governors of the provinces overpowered those who hated them and sought their evil - 9:1-3
- On the 13<sup>th</sup> - 15<sup>th</sup> day of the month of Adar, the Yehudim in Shushan rested and made it a day of feasting and gladness - 9:17-18
- The Yehudim of the villages who dwelt in the unwallied towns were making the 14<sup>th</sup> day of the month of Adar a good day of gladness and feasting, and for sending portions to one another - 9:19
- Morde<sup>k</sup>ai wrote and sent letters to all the Yehudim who were in all the provinces of Sovereign Ahashwerosh, to observe the 14<sup>th</sup> and 15<sup>th</sup> day of the month of Adar, yearly, as the days on which the Yehudim had rest from their enemies, as the month which was turned from sorrow to joy for them, and from mourning to a good day, that they should make them days of feasting and joy, of sending portions (shalach manos) to one another and gifts to the poor (matanot l'evyonim) - 9:20-22



- And the Yehudim undertook to do as they had begun, and as Mordekai had written to them, because Haman, son of Hammedatha the Agagite, the adversary of all the Yehudim, had plotted against the Yehudim to destroy them, and had cast Pur (lot) - to crush them and to destroy them - 9:23-24
- Therefore they called these days Purim (lots) - 9:26
- The Yehudim established and imposed it upon themselves and upon their seed and all who should join them, that without fail they should observe these 2 days every year, according to their writing and at their appointed time and that these days should be remembered and observed throughout every generation, every clan, every province, and every city, and that these days of Purim should NOT fail from among the Yehudim, and that the remembrance of them should not cease from their seed - 9:27-28
- And the decree of Ester established these matters of Purim, and it was written in the book - 9:32

### Chapter 10

- All the acts of King Ahashwerosh's power and his might, and the exact account of the greatness of Mordekai, with which the sovereign made him great, are they not written in the book of the annals of the sovereigns of Media and Persia? - 10:1-2
- And Mordekai the Yehudite was 2<sup>nd</sup> to King Ahashwerosh, and great among the Yehudim and pleasing to his many brothers, seeking the good of his people and speaking peace to all his seed - 10:3



# DIGGING DEEPER

Parents/Teachers may choose to use these prompts for further discussion of the lesson.

- Research the biography of King Ahashwerosh (Greek -Xerxes).
- The book of Ester contains no prophecy, no Torah instruction or even the mention of Yahweh. However, it contains much inspiration and demonstrates Yahweh's protection and deliverance to those who are faithful and obedient to Him wherever they may live. We are in exile just as the Yehudites were in the book of Ester. Do you think that this book is relevant to our walk?
- Discuss the prevalent theme that throughout history there have arisen those who wanted to destroy Yahweh's people and how Haman was a type of Hitler wishing to destroy all Yehudites.
- Research some traditions that brother Yehudah does for Purim and discuss them.
- Ester 2:17 says that Ester found favor (chen) and kindness/loving commitment (chesed) in the eyes of the king. Genesis 6:8 says that Noah found favor (chen) in the eyes of Yahweh. Genesis 19:19 says that Lot found favor (chen) in Yahweh's eyes and that Yahweh increased His kindness/loving commitment (chesed) by saving Lot's life. What does the Hebrew word chen and chesed mean? Is it merited or unmerited favor? Discuss.
- Notice that our hero is actually a woman that Yahweh chose to save His people. Discuss other Biblical characters that Yahweh used which may not seem like your typical heroes.
- Although Yahweh's name is never mentioned once in the entire story, He is the major theme in all events surrounding the rescuing and saving of His people. Discuss parts of the story where you see Yahweh clearly intervening on behalf of His people.
- Haman is referred to as an Agagite (a descendant of King Agag, the enemy of Yisr'ael and king of the Amaleqites). Research the history and the animosity between the Amaleqites and the Yisra'elites. Refer to Ex. 17:14; Deut. 25:17-19 & 1 Sam. 15.
- Discuss your thoughts on the king's verdict that Queen Vashti be removed as his wife for refusing to be paraded before all the men. Do you believe that she was being disrespectful for refusing to obey? Do you think that King Ahashwerosh was too harsh? Do you think that either of them regretted their decisions?
- Compare and contrast the different versions of the story of Ester found in the Septuagint versus the Masoretic text. What additions are found in the Septuagint that give extra information?
- Why do you think Mordekai refused to bow down to Haman? Was it more than just the physical act of bowing or was he stating that Haman had no authority over him?



# Searching Out Hebrew

Parents/Teachers can print out the '[Hebrew Pronunciation Guide](#)' to help with the pronunciation of Hebrew names and words. They can be cut out and used in conjunction with the Flashcards.

## WORDS

Parents/Teachers see the following page for 3 x 5 card cut outs of the words from this week's lesson. If printed on card stock, they can be kept in a box to reinforce learning.

Melek ( מֶלֶךְ ) - king/sovereign

Mishteh ( מִשְׁתֵּה ) - feast

Malkah ( מַלְכָּה ) - queen/sovereignty

Keter ( כֵּתֹר ) - crown

## NUMBERS

Parents/Teachers can print out these numbers to have as additional resources. These can be found under the 'Resources' tab on the YMTOI website.

2 - shtayim

3 - shalosh

6 - shesh

7 - sheva

30 - shloshim

50 - chamishim



# WORD MATCH

Match this week's Hebrew words to their correct definition.

Keter

Crown

Malkah

Feast

Melek

King/Sovereign

Mishteh

Queen/Sovereignness



# FLASHCARDS

מִשְׁתֵּה

**Mishteh**

Mish-teh

feast

כֵּתֶר

**Keter**

Ke-ter

crown

מֶלֶךְ

**Melek**

Me-lek

king/sovereign

מַלְכָּה

**Malkah**

Mal-kah

queen/sovereigness



# WRITING HEBREW

Mishte (feast)

משתה

Hey Tav Shin Mem  
משתה

Melek (king/sovereign)

מלך

Kaf Soft Lamed Mem  
מלך

Keter (crown)

כתר

Resh Tav Kaf  
כתר

Malkah (queen/sovereigness)

מלכה

Hey Kaf Lamed Mem  
מלכה



# Counting What You Gained

This next section is intended to be reinforcement of the lessons learned during this lesson. Choose the activities that best fit your child.

## STORING UP TREASURE IN MY HEART

The Katan Bet and Gadol memory verse is Ester 4:14. You can review the verse with them by reciting it out loud, acting it out, putting it to music...whatever works for you.

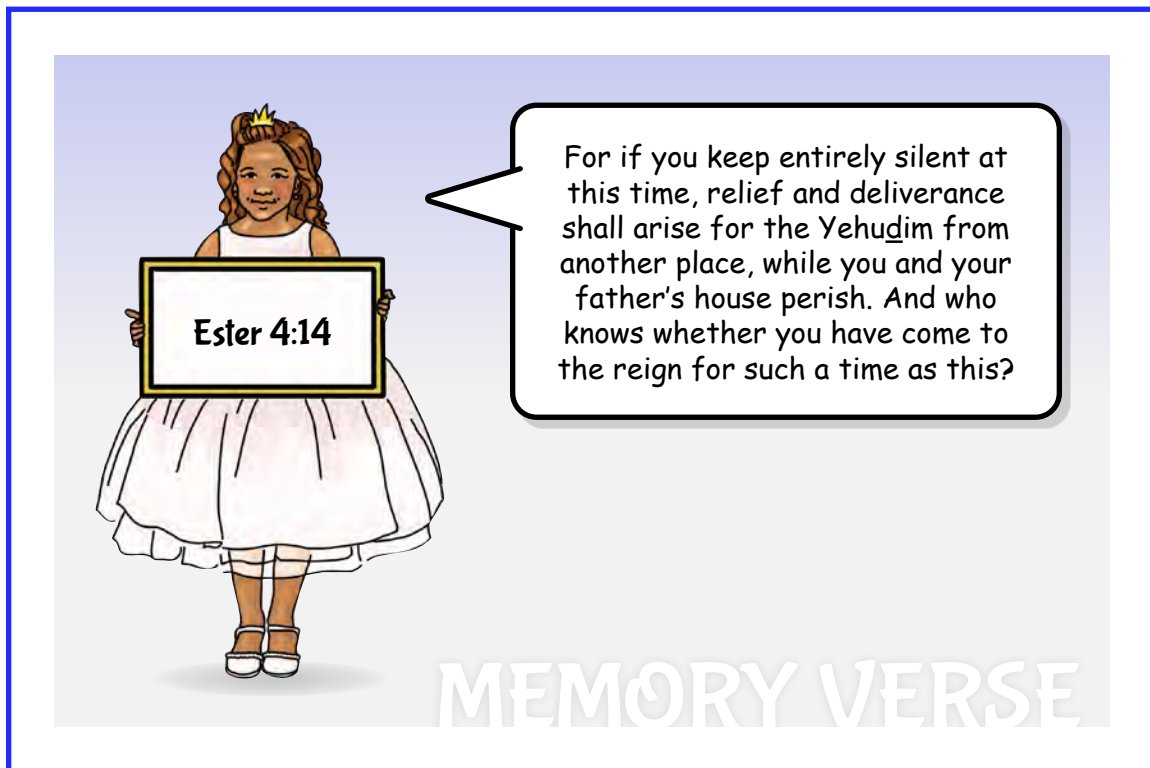

**Ester 4:14**

For if you keep entirely silent at this time, relief and deliverance shall arise for the Yehudim from another place, while you and your father's house perish. And who knows whether you have come to the reign for such a time as this?

MEMORY VERSE

Here is the link for this song:

[https://www.podomatic.com/podcasts/steveberkson/episodes/2022-03-11T06\\_38\\_08-08\\_00](https://www.podomatic.com/podcasts/steveberkson/episodes/2022-03-11T06_38_08-08_00)



# SEEKING TREASURE



1.

How many provinces did King Ahashwerosh rule over?

Circle the correct choice.

127   27   12   721

(1:1)

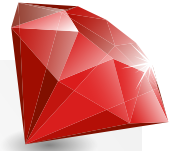

2.

What was the name of the first queen?

\_\_\_\_\_

(1:9)



3.

But Sovereign Vashti \_\_\_\_\_ to come at the sovereign's \_\_\_\_\_ brought by his eunuchs. And the sovereign was very \_\_\_\_\_, and his \_\_\_\_\_ burned within him.

(1:12)

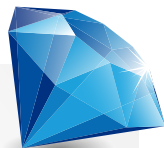

4.

What tribe was Morde<sup>k</sup>ai from?

Circle the correct choices.

Yehudah   Binyamin   Lewi   Yoseph

(2:5)



5.

What was the name of the first king who enslaved the Yehudites?

\_\_\_\_\_

(2:6)



6.

What 2 names did Morde<sup>k</sup>ai's cousin go by?

\_\_\_\_\_ and \_\_\_\_\_

(2:7)



7.

And Ester found favor in the eyes of all who saw her.

T / F

(2:15)

8.



Which 2 of the king's eunuchs plotted against him?

Circle the correct choices

Bigthan Karshena Memukan

Harbona Teresh

(2:21)

9.

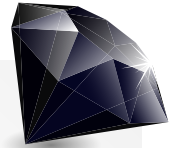

Who did King Ahashwerosh promote over all the other princes?

\_\_\_\_\_

What nation was he from?

\_\_\_\_\_

(3:1)

10.



And all the sovereign's servants who were in the sovereign's gate \_\_\_\_\_ and did \_\_\_\_\_ to Haman, for so the sovereign had commanded concerning him. But Mordekai would NOT \_\_\_\_\_ or do \_\_\_\_\_.

(3:2)

11.

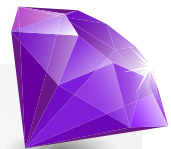

What is the Hebrew word for lot?

\_\_\_\_\_

(3:7)

12.



How many silver talents did Haman pledge to give into the treasury to take care of those who were going to destroy the Yehudim?

Circle the correct choice.

1 million 10,000 100,000

(3:9)

13.

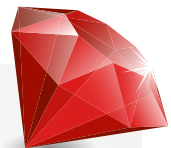

Write down the day, month and month name for when this was going to take place.

\_\_\_\_\_ day of the \_\_\_\_\_

month which is the month of \_\_\_\_\_.

(3:13)

14.

And Mordecai commanded them to answer Ester, "Do NOT \_\_\_\_\_ within yourself to \_\_\_\_\_ in the sovereign's palace any more than all the other Yehudim. For if you keep entirely \_\_\_\_\_ at this time, \_\_\_\_\_ and \_\_\_\_\_ shall arise for the Yehudim from another place, while you and your father's house \_\_\_\_\_."  
\_\_\_\_\_?"



(4:13-14)

15.

How many days did Ester ask the Yehudim in the palace to fast with her and her young women?

Circle the correct choice.

1 week    1 day    3 days

(4:16)

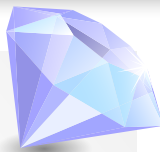

16.

Haman's wife Zeresh told him to make a wooden structure 50 cubits high.

T / F

(5:14)



17.

What did Haman suggest to King Ahashwerosh be done to the man in which the king delighted to value?

Circle the correct choices.

royal robe    spa day    special feast  
ride on horse with royal crest

(6:7-8)

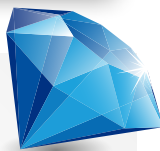

18.

After Haman was hung and Mordecai replaced him, what items did Mordecai receive?

Circle the correct choices.

signet ring    Haman's house  
royal garments of blue and white    gold crown  
royal stallion    fine linen and purple garment

(8:2, 15)



19.

What are some customs we can do on this feast?

\_\_\_\_\_  
\_\_\_\_\_

(9:22)



20.

What are these days called?

\_\_\_\_\_

(9:26)

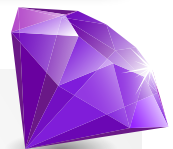

# WORD SEARCH

Search for the hidden words from this week's lesson.



AHASHWEROSH

MEDES

ESTER

OBEISANCE

PLUNDER

ASHES

HANG

VASHTI

SHUSHAN

HAMAN

LOTS

PROVINCE

FASTING

GLADNESS

PERSIANS

MORDEKAI

FEAST

SILVER

SACKCLOTH

PETITION

PURIM



# Answer Key

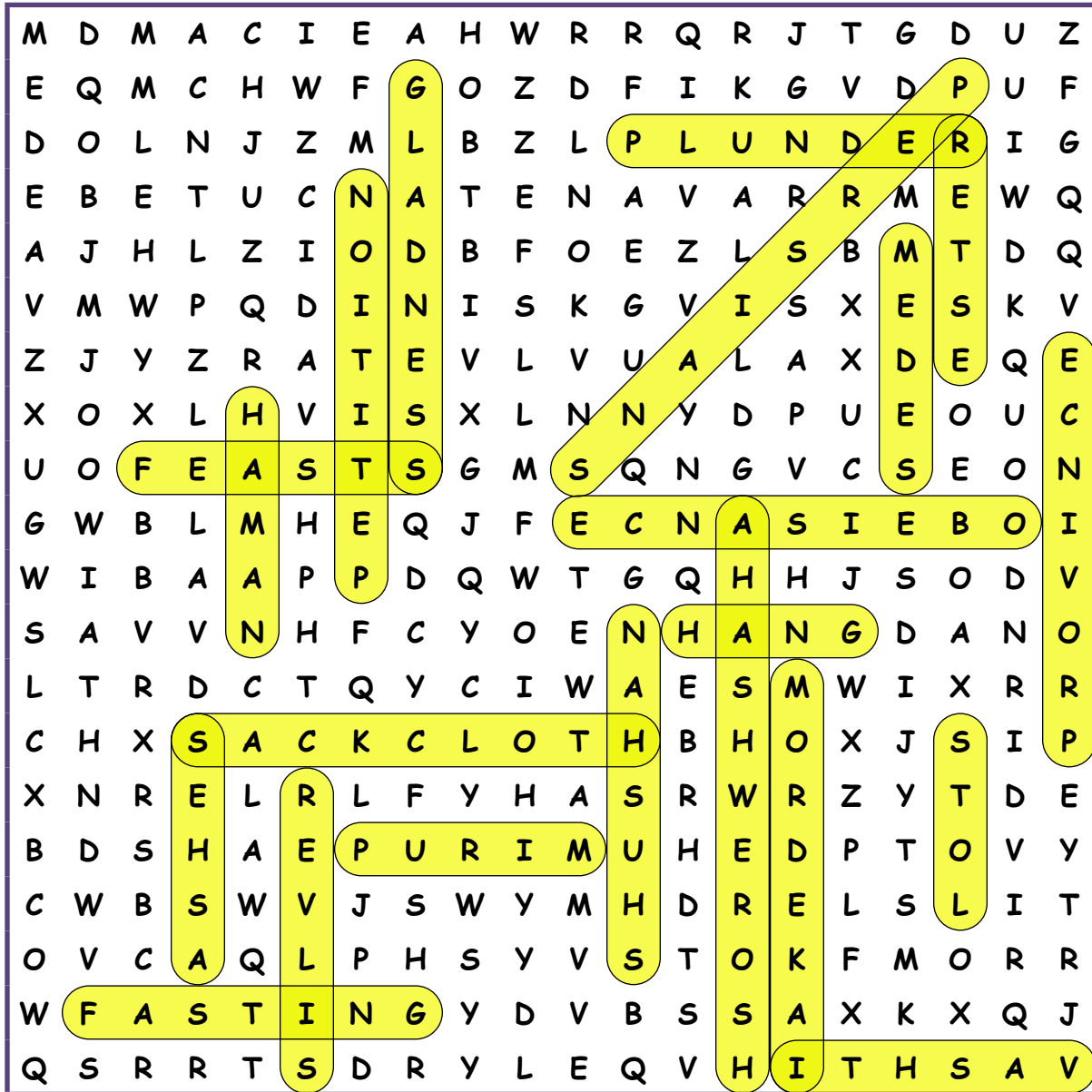

AHASHWEROSH

MEDES

ESTER

OBEISANCE

PLUNDER

ASHES

HANG

VASHTI

SHUSHAN

HAMAN

LOTS

PROVINCE

FASTING

GLADNESS

PERSIANS

MORDEKAI

FEAST

SILVER

SACKCLOTH

PETITION

PURIM



# CROSSWORD PUZZLE

Complete the crossword using words from this week's lesson.

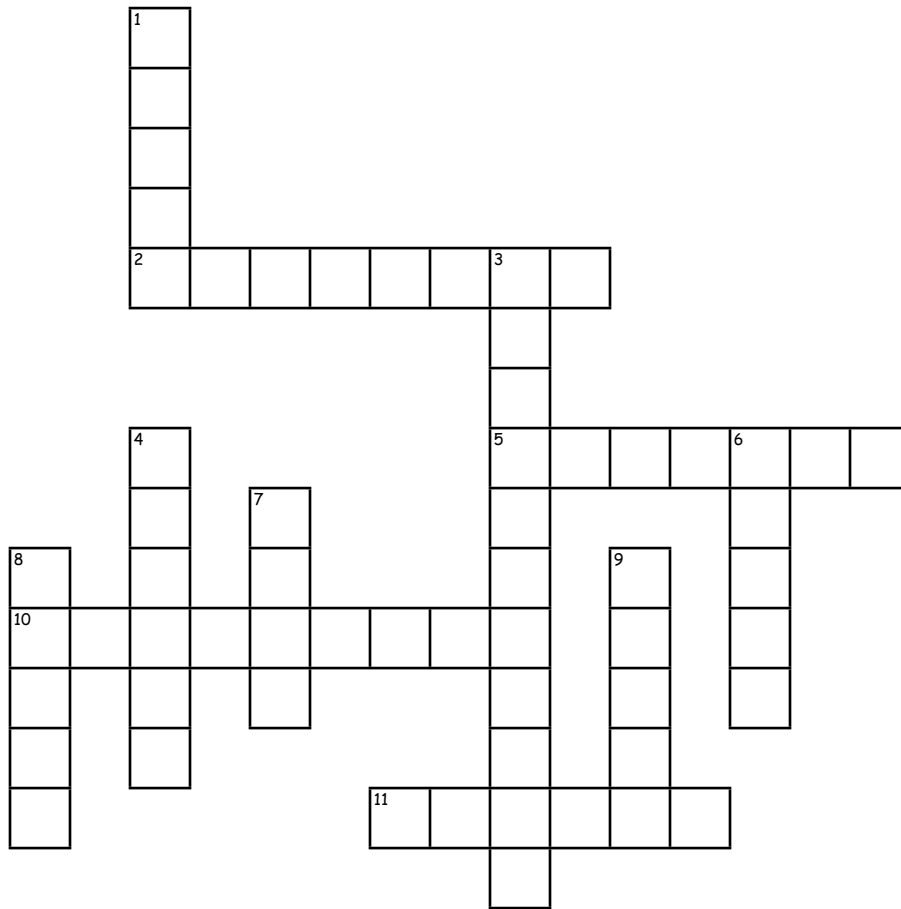

## Across

2. The name of Ester's cousin and adopted father.
5. The place where Ester and Mordeḳai lived.
10. Everyone was to do \_\_\_\_\_ to Haman.
11. Name of first queen of King Ahashwerosh.

## Down

1. Name of this feast.
3. Name of king of Media and Persia.
4. Haman's wife's name.
6. Name of our villain in this story.
7. Ester asked the Yehudim to do this for 3 days.
8. Mordeḳai was ridden around on a \_\_\_\_\_.
9. The king and queen held a \_\_\_\_\_.



# Answer Key

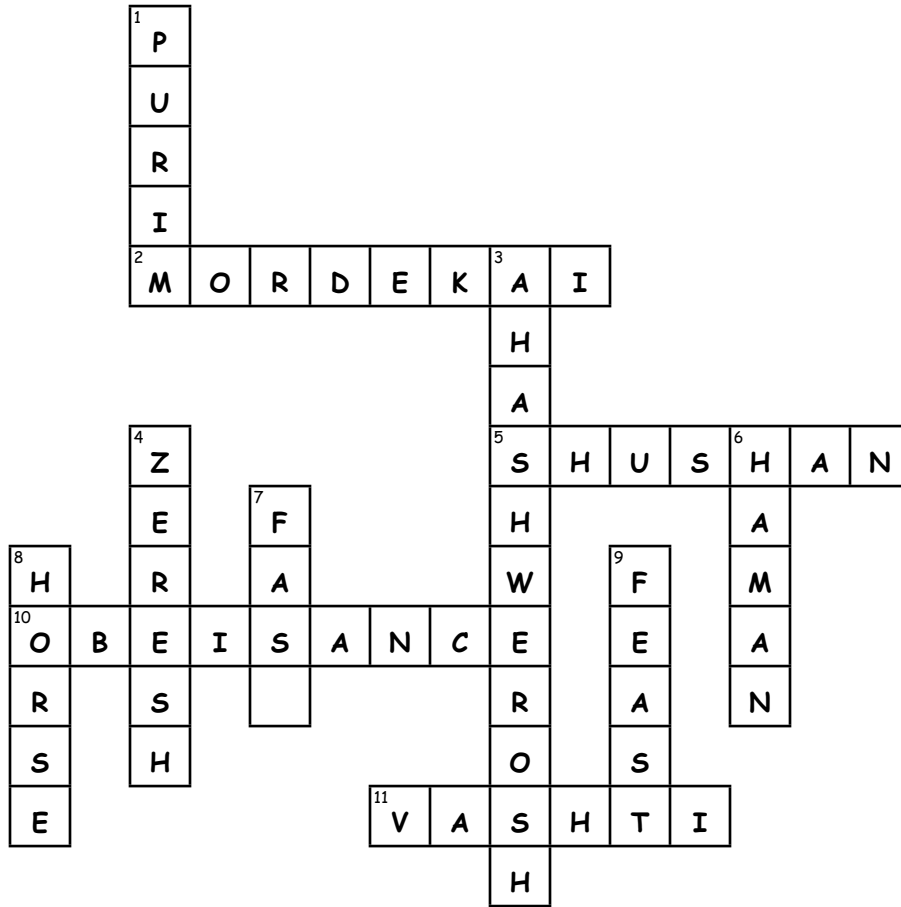

## Across

2. The name of Ester's cousin and adopted father. **Mordekai**
5. The place where Ester and Mordekai lived. **Shushan**
10. Everyone was to do **obeisance** to Haman.
11. Name of first queen of King Ahashwerosh. **Vashti**

## Down

1. Name of this feast. **Purim**
3. Name of king of Media and Persia. **Ahashwerosh**
4. Haman's wife's name. **Zeresh**
6. Name of our villain in this story. **Haman**
7. Ester asked the Yehudim to do this for 3 days. **fast**
8. Mordekai was ridden around on a **horse**.
9. The king and queen held a **feast**.



# MAZE

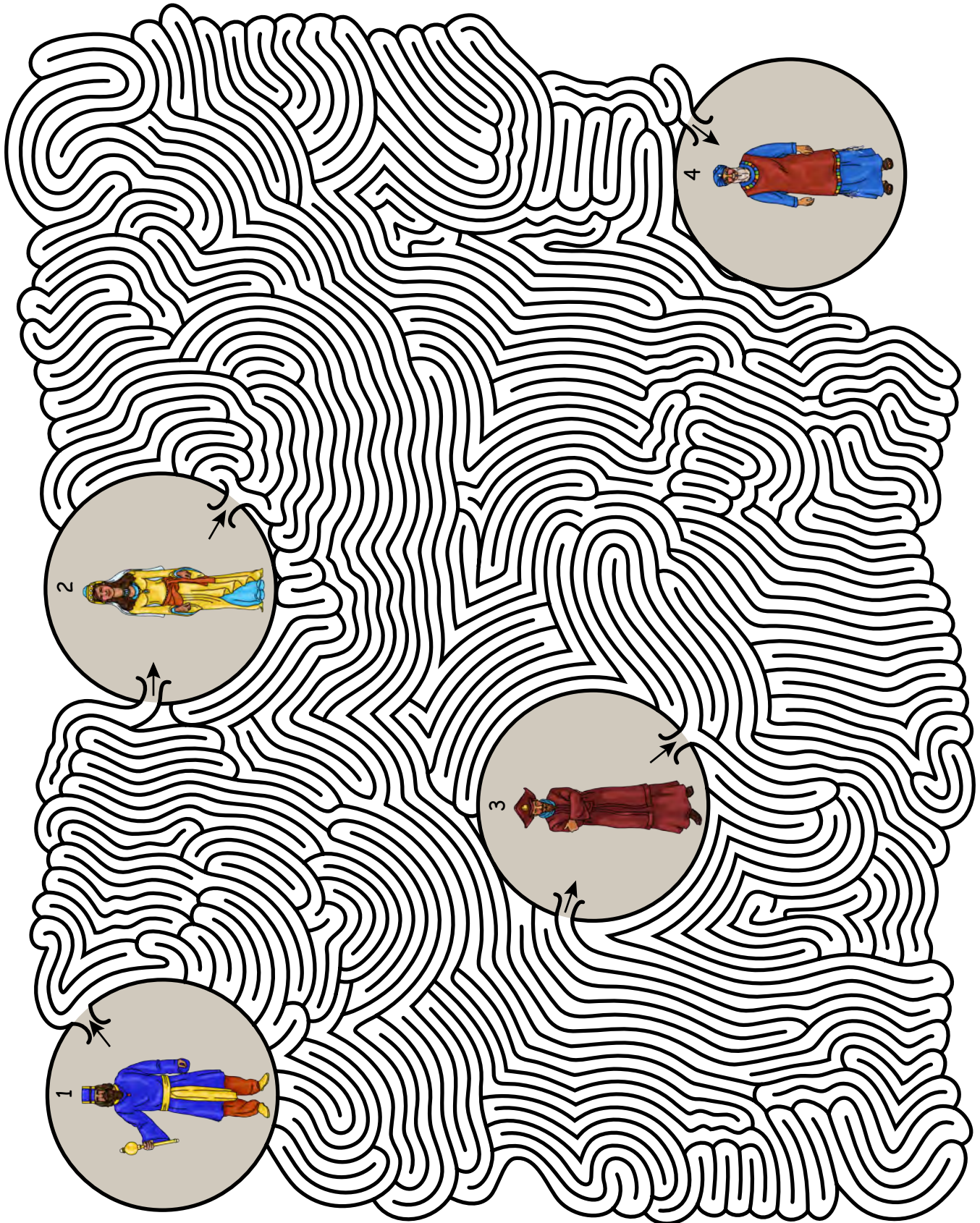

# Precious Possessions

## NOTEBOOK PAGE

### Materials:

- Cardstock - white
- Double-sided adhesive foam dimensionals
- Brads
- Toothpick - color of choice
- Jewels, gems or sequins of choice
- Puncturing tool
- Glue & hot glue
- Pencil
- Scissors
- Coloring pencils, crayons or markers
- Notebook Templates: Main Page & A (BW) or Main Page & B (color)

#### Parent/Teacher Preparation:

- Print Notebook Templates of choice on white cardstock.

### Ester Goes Before the King

Ester 5:1-2



### Instructions for the Notebook Page:

- If using BW Templates, color using medium of choice.
- Cut out all Template pieces. (P1)
- If using colored Templates, color banner as desired. (P1)
- Embellish Queen Ester and King Ahashwerosh with jewels, gems or sequins as desired. (P2)



P1

#### Attaching King Ahashwerosh and Queen Ester to Main Page

- Using a puncturing tool, poke a hole through each 'x' on the king and Ester.
- Position the king on the Main Page near the throne so that his feet touch the edge of the stage. (P3)
- Position Ester to the left and below the stage so that the king's scepter can touch her head when she bends. (P3)



P2

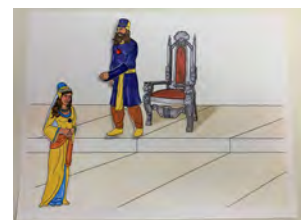

P3

## Instructions for the Notebook Page Cont'd:

- Insert a brad through the shoulder and torso of the king. (P4)
- Using a pencil, mark where the shoulder brad lines up with the Main Page. (P4)
- Using a puncturing tool, poke a hole through the Main Page.
- Push the brad on the king's shoulder through the cardstock to attach the king to the Main Page. (P5)
- Attach the forearm piece to the shoulder piece at the elbow with a brad. (P6)
- Using glue of choice, add glue to both legs of the king to attach him to the Main Page. (P7)
- The king is now completed. His arm and shoulder should be able to move up and down. (P8)
- Insert a brad through the 2 holes to connect Ester's body. (P9)
- Using a pencil, mark where the brad lines up with the Main Page.
- Using a puncturing tool, poke a hole through the Main Page.
- Push the brad through the cardstock to attach Ester to the Main Page. (P10)



P4

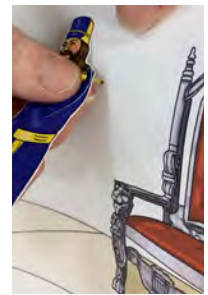

P5



P6



P7

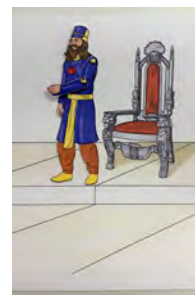

P8



P9

### *Creating the King's Scepter*

- Using a colored toothpick, hot glue 2 half round gems to either side. (P11)
- Hot glue the 'scepter' to the back of the king's hand. (P12)

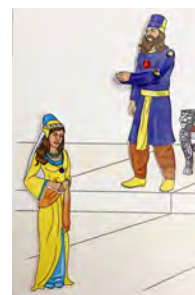

P10

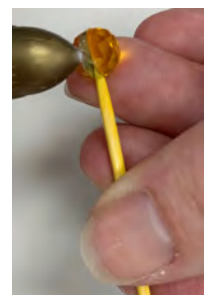

P11



P12

# Instructions for the Notebook Page Cont'd:

## Hebrew Words

- Write the following Hebrew words on each side of the banner: (P13)
  - 1) Melek      2) מלך      3) King
  - 1) Malkah    2) מלכה    3) Queen



P13

## Attaching the Banner

- Adhere double-sided adhesive foam dimensionals to the back of the banner and the Main Page. (P14)
- Place the banner on the right side of the Main Page so that the wood tip touches the stage. (P15)



P14



P15

*You now have a visual representation of Ester standing before the king and then bowing as he extends his scepter to her. (P16, P17)*



P16

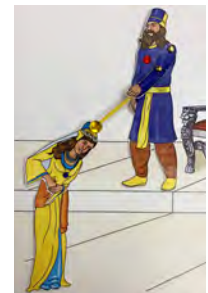

P17

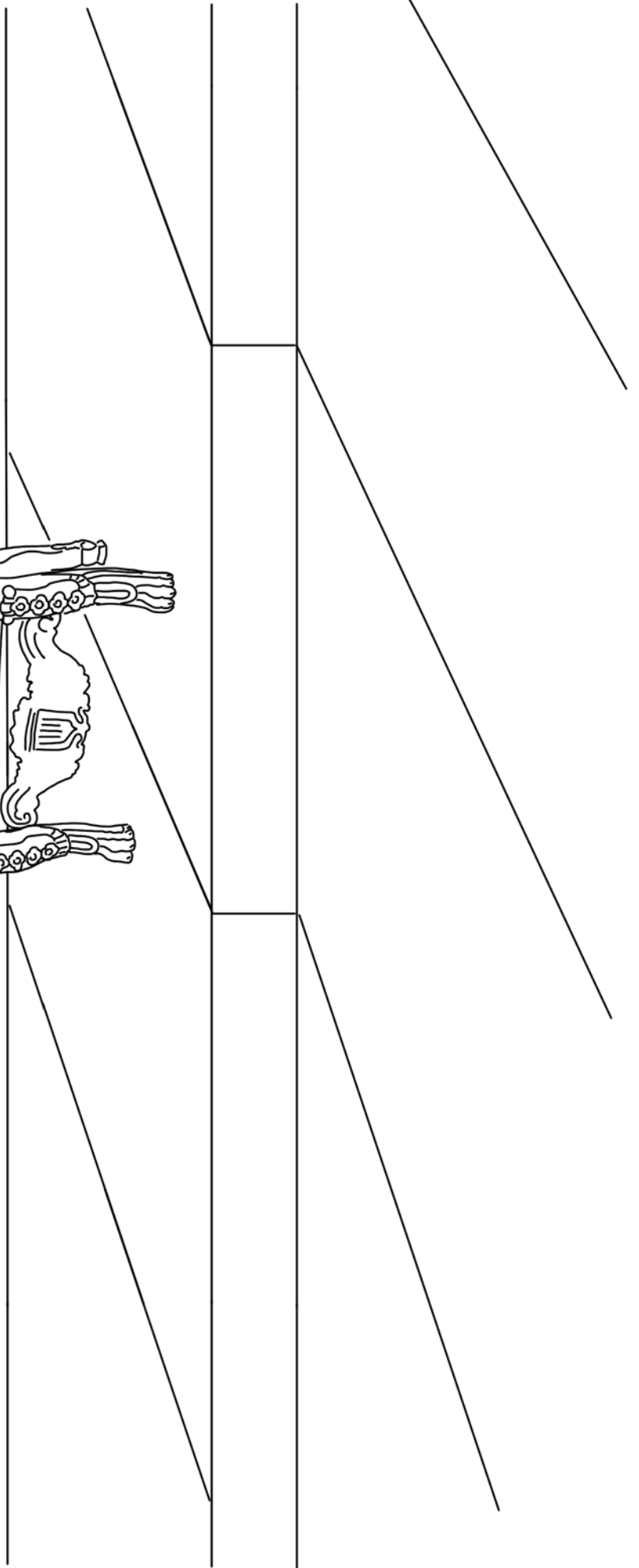
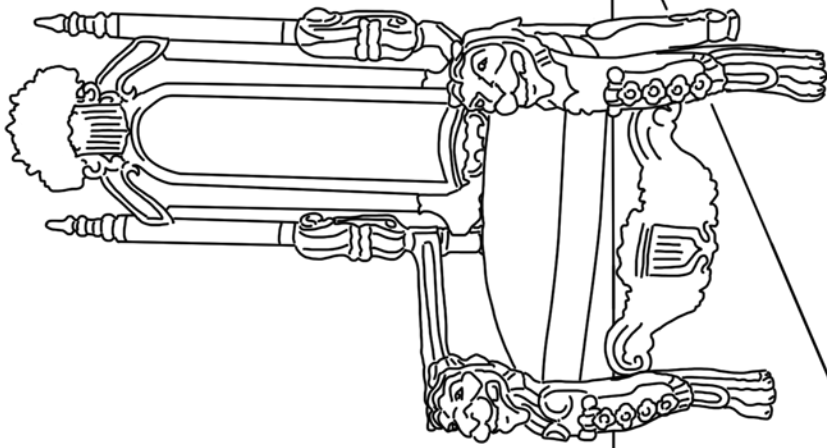

Notebook Template A (BW)

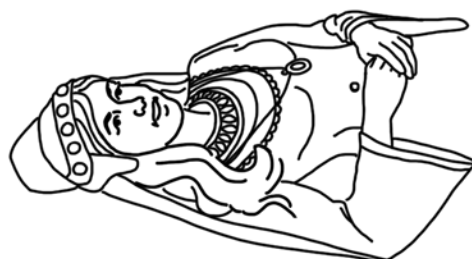
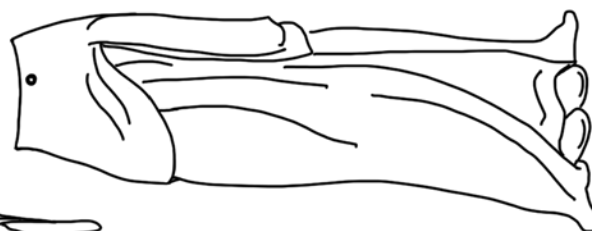
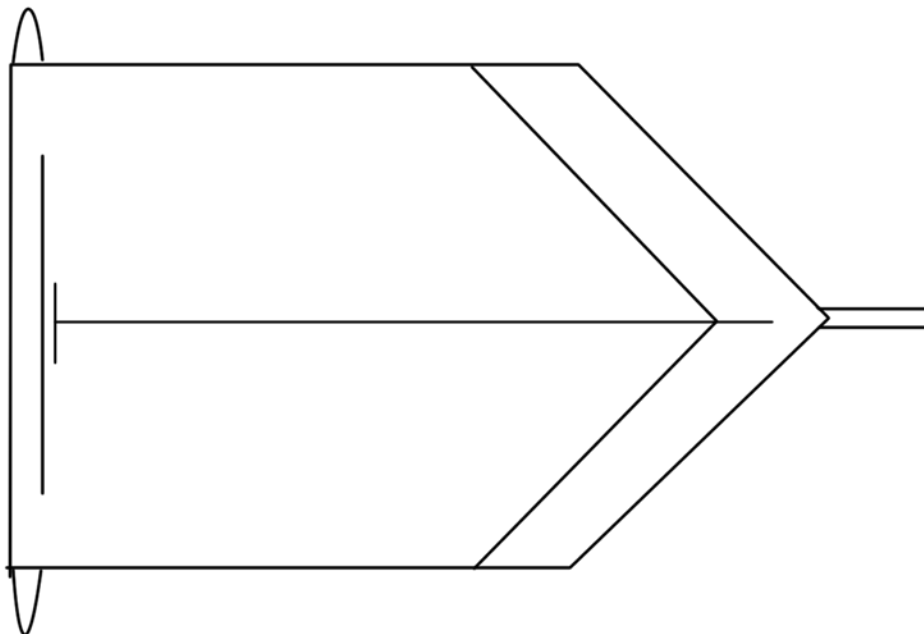
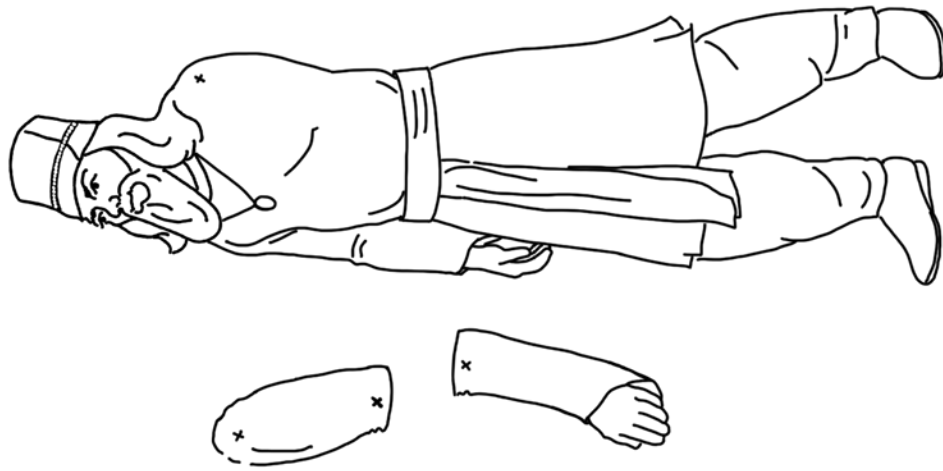

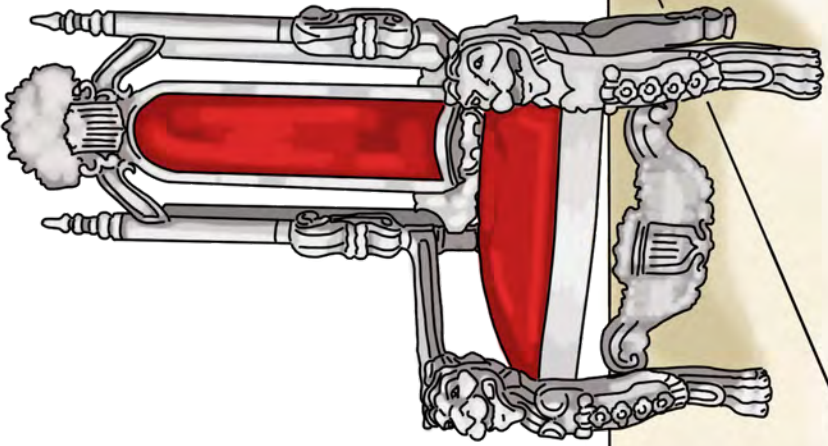

Notebook Template B (color)

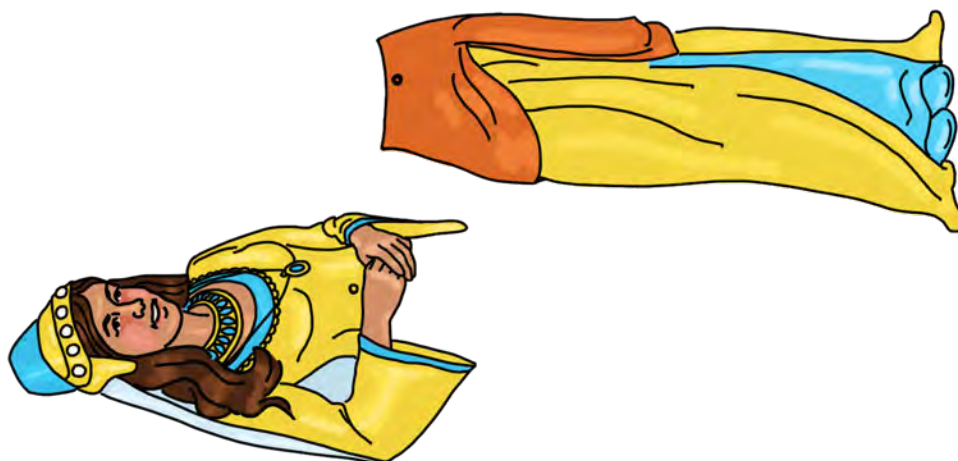
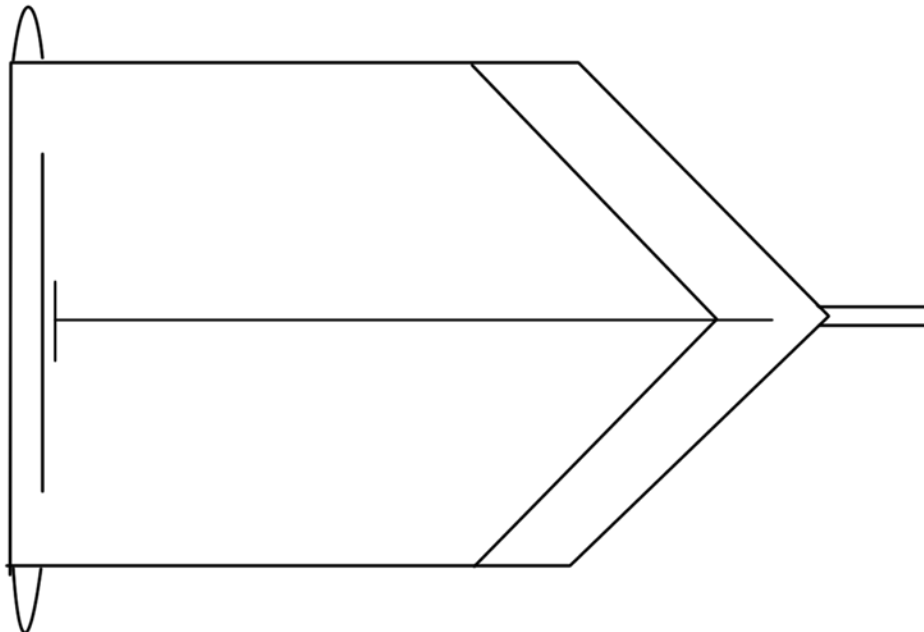
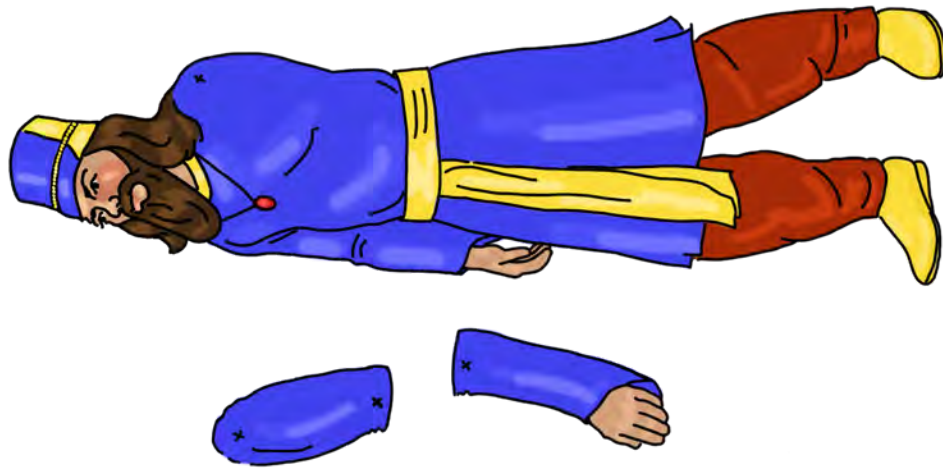

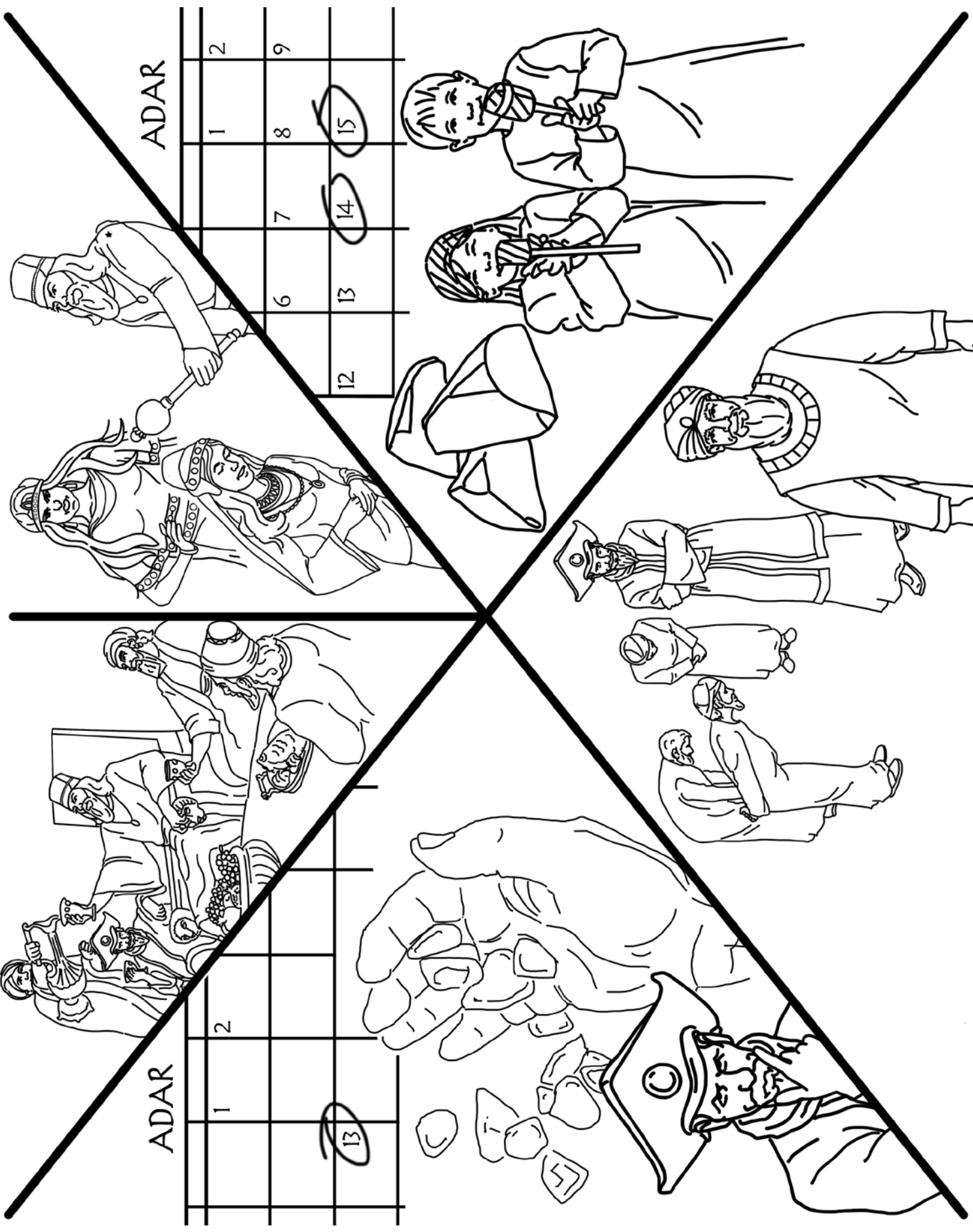

ADAR

1	2				
		8		15	
		7		14	
		6		13	
				12	

ADAR

1	2				
				13	

Q U I N I M

"Chag HaPurim"  
The Feast of Lots

Q U I N I M

---

# Sweetness of Torah

---

## SWEET SOUNDS OF TORAH

(Sing Praises to His Name)

Here is the link for this song:

[https://www.podomatic.com/podcasts/steveberkson/episodes/2018-02-25T07\\_27\\_19-08\\_00](https://www.podomatic.com/podcasts/steveberkson/episodes/2018-02-25T07_27_19-08_00)

### Ester's Song

Ester was a girl from far away  
She lived a simple life and loved Yahweh  
A king was looking for his bride to be  
He fell in love and called this girl his queen  
Her people were the chosen ones of Yah  
Living in a distant land as slaves  
The king had put Yah's people in harm's way  
But Yah had chosen Ester to be brave



### Chorus

For I know the plans I have for you, says Yahweh  
Not to harm you, but to prosper  
Plans to give you hope and future (repeat)

You might be scared, but hold onto the truth  
Yahweh provides and He will not leave you  
And when you feel alone, remember you are His  
For you are called for such a time as this

Oh, Oh, Oh

# SWEET TASTE OF TORAH

This snack relates to this week's lesson. Please take these as suggestions and make necessary changes based on your individual dietary needs.

Here is a video link for this snack: <https://www.youtube.com/watch?v=OPtkXa49sP8>

## Hamantashen

Haman's Hat



### Ingredients:

- 4 eggs
- 1 c. vegetable oil
- 1 $\frac{1}{4}$  c. sugar
- 2 tsp. vanilla
- 3 tsp. baking powder
- $\frac{1}{2}$  tsp. salt
- 5 $\frac{1}{2}$  c. all-purpose flour
- Filling of choice: apricot, poppy seed, prune, etc...

### Instructions:

Preheat oven to 350 degrees. Beat eggs. Add oil, sugar, vanilla, baking powder and salt. Gradually add flour. Knead until smooth. Roll out and cut into 3-4" circles.

Place filling in center. Pinch together sides to form a triangle. Place on lightly greased baking sheet. Bake for 20-30 minutes. Makes 20 cookies.