

Terumah

"Contribution"

Exodus 25:1 - 27:19
Katan Aleph



In This Edition:

19.1 - Blueprints for the Mishkan Furnishings
Exodus 25:8-40; 26:34-35; 27:20-21; 30:1-10, 34-38; 37;
Leviticus 24:1-9; Numbers 8:1-4



Table of Contents

Parsha Pearls is a comprehensive resource that allows for complete customization by the parent. We understand that if you were to strive to accomplish all aspects of each lesson in one day it would be unrealistic and also overload for the child. It is our intention that this be used 'a la carte' so that it suits your specific needs. Our site caters to printing only the pieces you choose.

This page will provide quick links to get to the portion of the document for which you are looking. When you hover over the title a finger will appear. Click on it and you will be taken directly to that page.

If you are new to Parsha Pearls, we have created an [Introduction](#) document outlining how to use our lessons, as well as a [Scriptural Inspiration](#) document, which explains our titles and the Scriptural inspiration for them. We pray that Parsha Pearls blesses your home and that your children will grow to love the Word and to never depart from keeping Torah. As always, feel free to email us at parshapearls@mtoi.org if you have any questions.

Gem Seeking (The Main Lesson)	3
➤ Little Gems Story (Story for Younger Children)	3
➤ Little Gems Story Characters	6
Counting What You Gained (Worksheets)	12
➤ Storing Up Treasure in My Heart (Memory Verse)	12
➤ Seeking Treasure (Questions from the Parsha)	14
➤ Word Search	15
➤ Maze	16
Precious Possessions (Arts & Crafts)	17
➤ Craft	17
➤ Coloring Page	18
Sweetness of Torah	19
➤ Sweet Sounds of Torah (Song Corresponding to the Parsha)	19
➤ Sweet Taste of Torah (Snack Corresponding to the Parsha)	20
Next Week's Treasure Hunt (Looking Ahead to Next Week's Parsha)	21



Gem Seeking

LITTLE GEMS STORY

Parent/Teacher Preparation:

Please see the [Instructions for the Little Gems Story](#) on the YMTOI website. This will help you to understand how to prepare for the story.

Terumah – Blueprints for the Mishkan Furnishings

Shalom children! Today we are going to start on a whole new journey with the children of Yisra'el. We will learn about the most important structure ever made, called the Set-apart Place. This is where Yahweh said He wanted to dwell with His people. Our story begins with Mosheh still at the top of Mount Sinai. **(Place Mosheh and mountain on board.)** We just learned about the Ten Commandments **(place tablets on board)** that Yahweh gave His people, but Yahweh has a lot more to tell Mosheh because he will be up there for 40 whole days.

Yahweh is sharing with Mosheh the pattern He wants for His Set-apart Place, including each measurement, all the rich materials, the furniture pieces, and the purpose for each item. It's like an architect who makes blueprints for the workers to follow, and an interior designer who designs special furniture for homes. **(Place blueprints and fancy chair on board.)** Yahweh is the master architect and designer of this project, and He is telling Mosheh the exact way He wants His Set-apart Place to look. Later on, Mosheh will carefully write down everything Yahweh told him up there and share it with the children of Yisra'el. **(Place scroll on board.)** We will get to that story in another parsha.

Hey, I just remembered someone else who got instructions and a pattern from Yahweh to build something! Do you remember a man named Noah? **(Place Noah on board.)** Yeah, Yahweh gave him instructions on how to build an ark. That ark was a large boat. **(Place ark on board.)** This time Yahweh is going to ask for a different kind of ark, one that would allow Him to be in the middle of His people. He told Mosheh, "I am going to tell you how I want my place to be built, what materials to use, and what I want in it."

Yahweh said, "I want you to use acacia wood." **(Place acacia wood on board.)** The other ark, Noah's ark, was made of a different wood called gopher wood. **(Place gopher wood on board.)** We know Yahweh is always very specific with what to use when He gives instructions.

He said, "Make me an ark that is shaped like a shoe box." Actually, Yahweh didn't say 'shoe box', because we know they didn't have stores back then, but just for a moment I want you to imagine that shape. **(Ask children what shape a shoe box is.)** But it was larger than a shoe box, more like the size of a treasure chest. **(Place treasure chest on board.)**

(Remove all characters from board except for treasure chest, Mosheh and mountain.)



(Place ark of the Witness on board and point to each item as you read about it.)

Yahweh said He wanted all the wood to be covered in gold inside and outside of it. And He wanted it to have a molding. This is like the long, pretty strips that you can see sometimes in a house, right where the wall meets the ceiling. He wanted that on all sides of the ark. He also wanted them to make gold rings, big ones that you could slide a pole in. He wanted the rings by each corner of the ark, with the poles made out of the same wood and then covered in gold. Man, that was one shiny box! The poles would be used to carry the ark.

You remember how Noah's ark was used to carry Noah's family and the animals? Well, Yahweh wanted some things carried in this ark too. No, not animals - it was too small. But He wanted them to carry the tablets that He wrote on. **(Place tablets on board.)**

And of course, just like a shoe box, the ark needed a lid. So, Yahweh told them they were to make a lid called the lid of atonement, and He gave Mosheh the measurements so that the lid would fit the ark. But He didn't say to make it out of wood. He said, "Make it out of clean gold, to fit on top of the ark."

Yahweh also wanted 2 golden kerubim to go on top of the lid. Do you know what kerubim are? The Scriptures say that kerubim are heavenly beings, who worship Elohim at His throne. Now, I don't really know what they look like, but Yahweh told them to make the kerubim face each other, with their wings covering the lid and their faces turned downwards. He said that after it was built, Yahweh would talk to Mosheh from the top of the lid of atonement. **(Remove treasure chest from board.)**

(Place table of showbread on board and point to each item as you read about it.)

Next, Yahweh told Mosheh how to build a special table, to be made of acacia wood and covered in gold. It was to hold the showbread which were 12 loaves of bread to represent the 12 tribes of Yisra'el. Now, the table was not as big as the ark, but it was just as tall. The table was also to have a molding, and a rim as well as a ring on each corner by the legs, to hold its own poles, just like the ark. They also needed to make ladles and jars and dishes and bowls. **(Place table of showbread utensils on board.)** Sounds like the stuff we use for dinner, only it wasn't for dinner.

(Place 7-branch lampstand on board and point to each item as you read about it.)

Yahweh also wanted a lampstand with 7 branches. Many people have a menorah in their house to remind them of the lampstand. Do you have one in your home? This lampstand was to be made exactly the way Yahweh said, with almond flower-shaped oil holders, and knobs where the branches came out from it. It was to be made of pure gold, all of one piece! I can't even imagine how challenging that was for the person who got that job! There was a lot of detail in making that menorah. Yahweh also told Mosheh that He wanted the children of Yisra'el to bring the olive oil to keep this lampstand lit all the time. **(Place olive oil on board.)**

(Place altar of incense on board and point to each item as you read about it.)



The last furniture piece that Yahweh gave Mosheh instruction for was the altar of incense. This piece was also shaped like a shoebox but standing up. It was to be made of acacia wood and gold overlay on its top and its sides all around. Just like the ark it was to have 4 gold rings on its sides and 2 poles that went into the rings so that when the altar of incense had to be moved, it was easier to lift and carry. It was to have something different on it from the other furniture pieces - 4 horns on its 4 corners. Aharon was to make an offering on it once a year on the Day of Atonement. But we will learn about that another time.

Aharon was also to put incense on this altar every morning to start the day by offering it to Yahweh as a sweet smell to Him. It's like your favorite perfume, or a flower that you enjoy smelling. That's the way Yahweh felt about this special incense. Yahweh gave Mosheh the special recipe for them to follow to make this set-apart incense. **(Place incense on board.)**

No one was allowed to copy this scent. It was only to be used for the altar of incense. If someone broke the rules, they would have to leave the camp and never return. I hope no one ever broke that rule.

So children, now we have all the furniture pieces that Yahweh wanted built for His Set-apart Place. I wonder where these pieces will go. Do you think Yahweh will tell Mosheh about that? **(Let children answer.)** I do too!

Well children, we have come to the end of our story for today. We will see you next week for another exciting Little Gems story!





Mosheh



Tablets

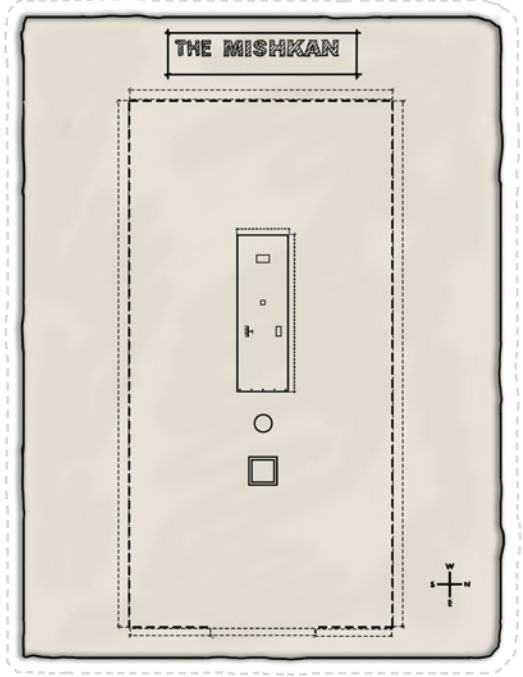

Blueprints

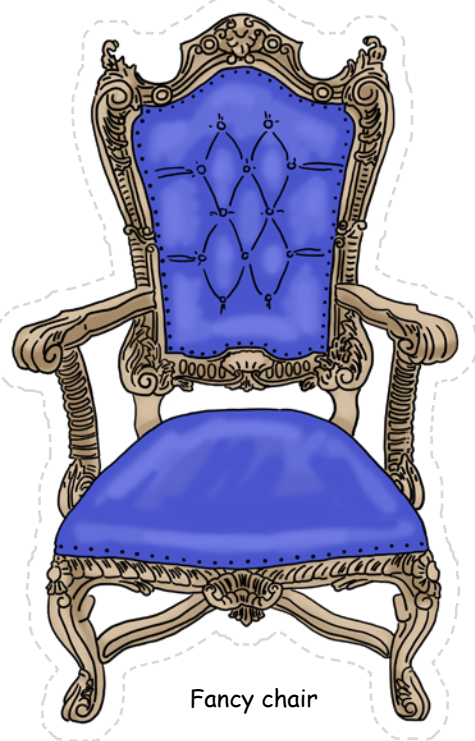

Fancy chair

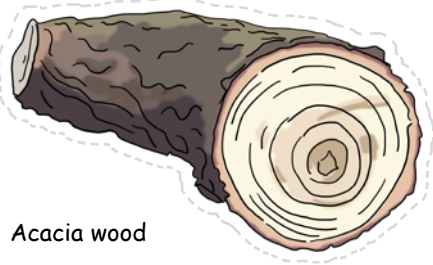

Acacia wood



Noah

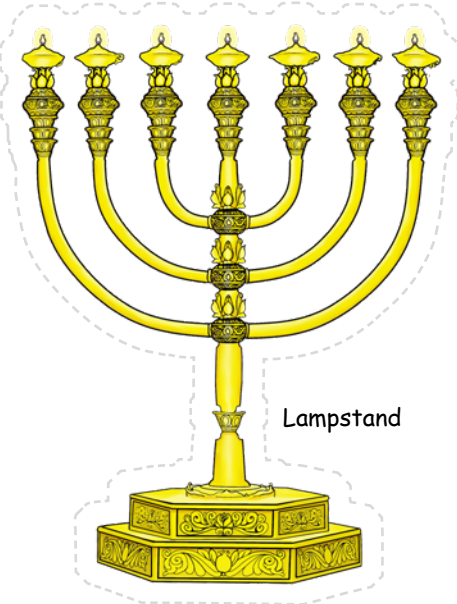

Lampstand

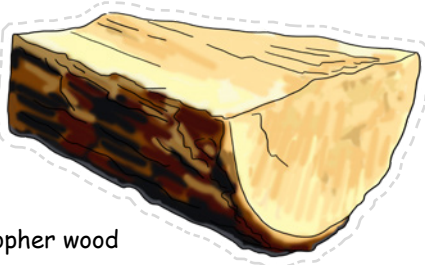

Gopher wood

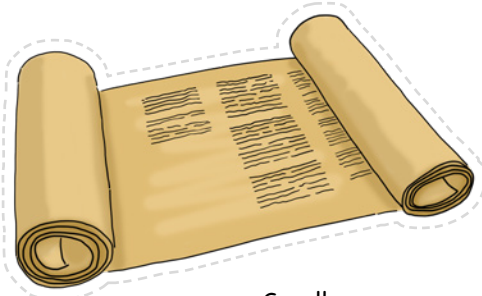

Scroll



Mountain

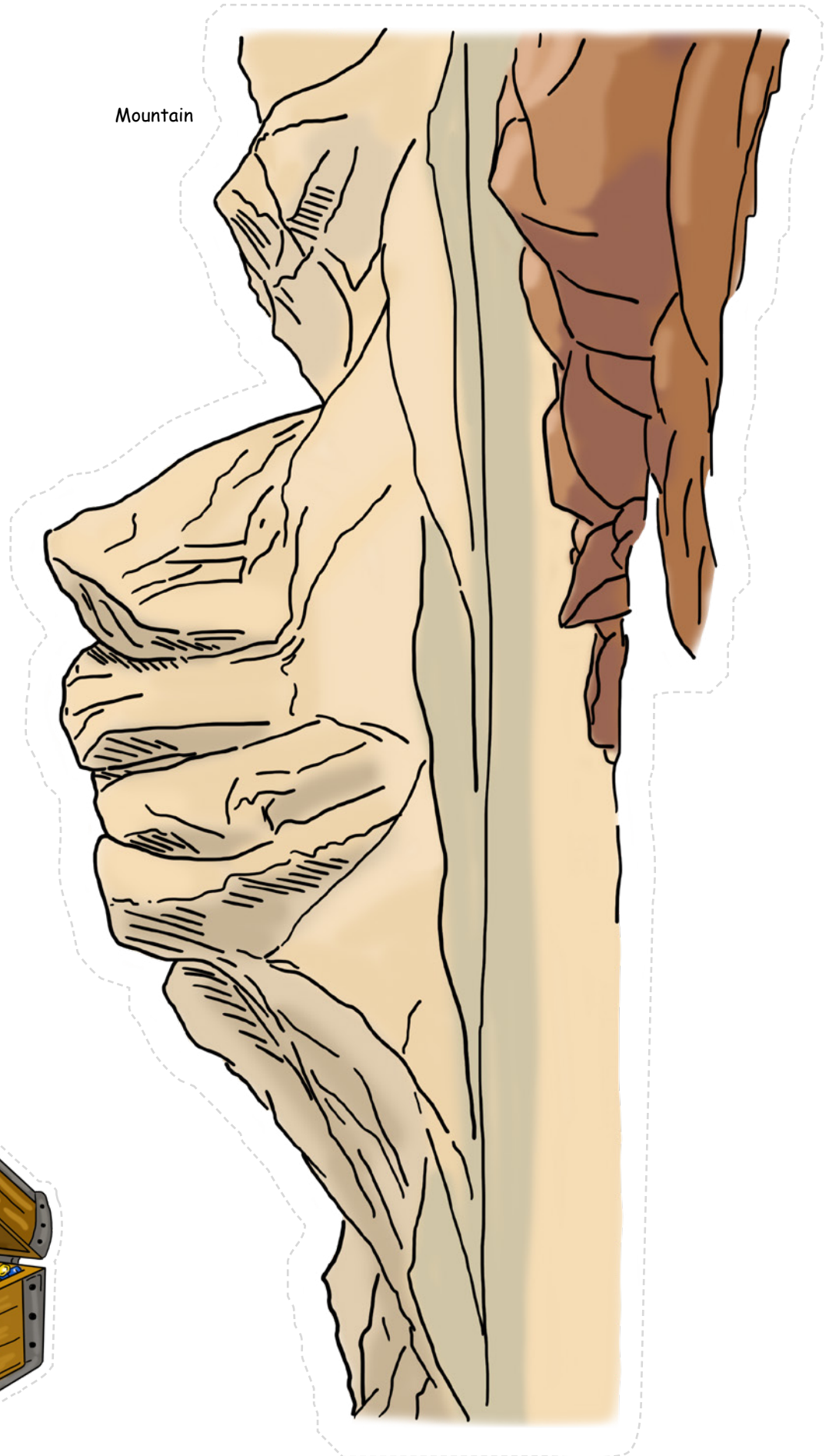

Treasure chest



Ark of the Witness

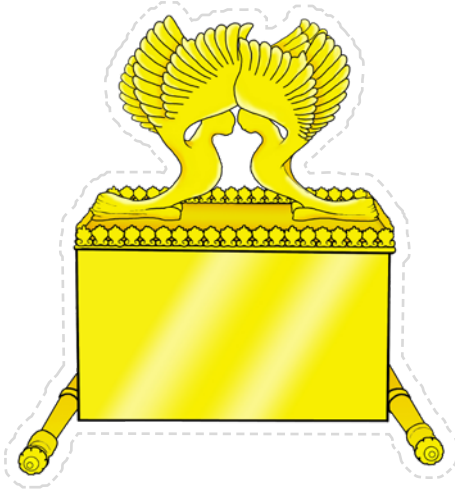
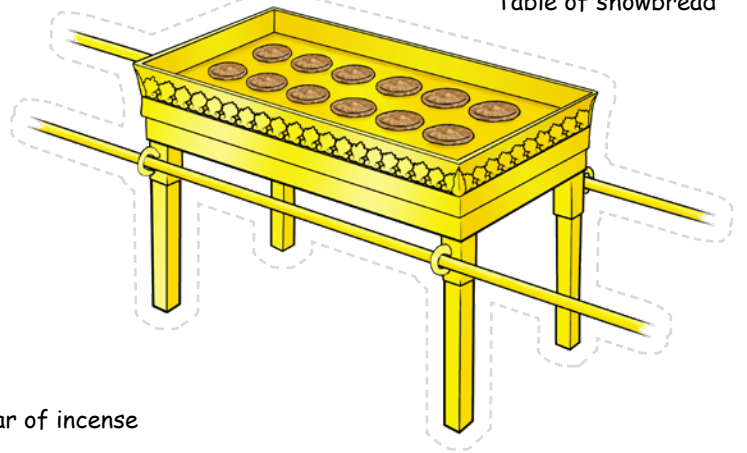

Table of showbread



Altar of incense

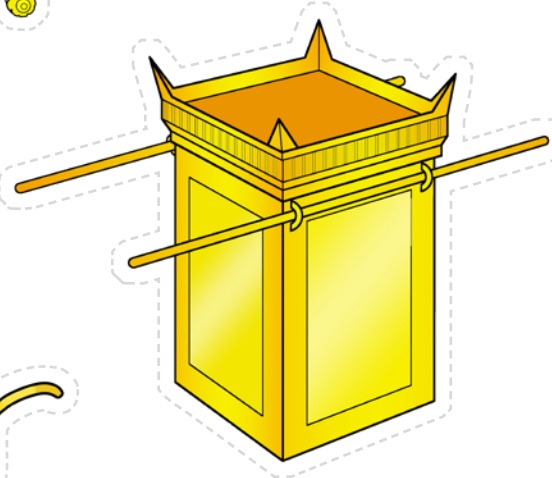
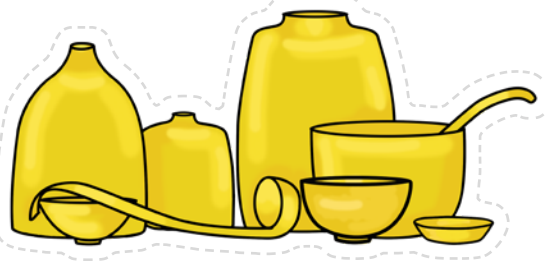

Table of showbread utensils



Incense



Olive oil

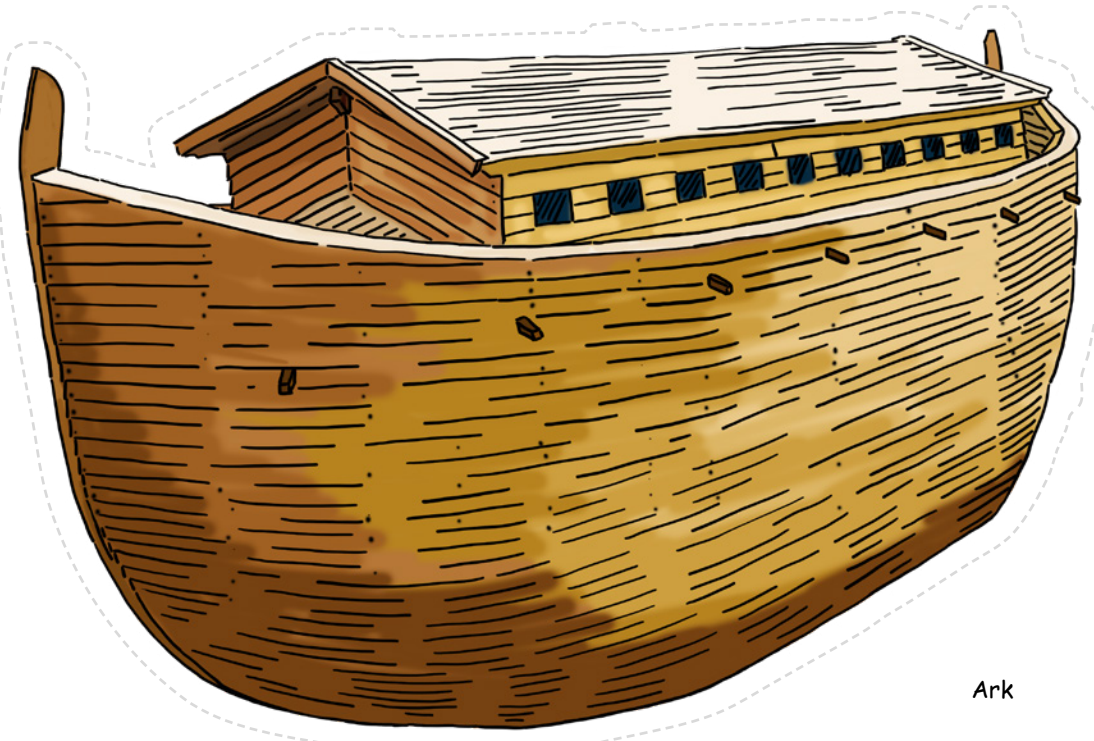

Ark



Mosheh



Tablets

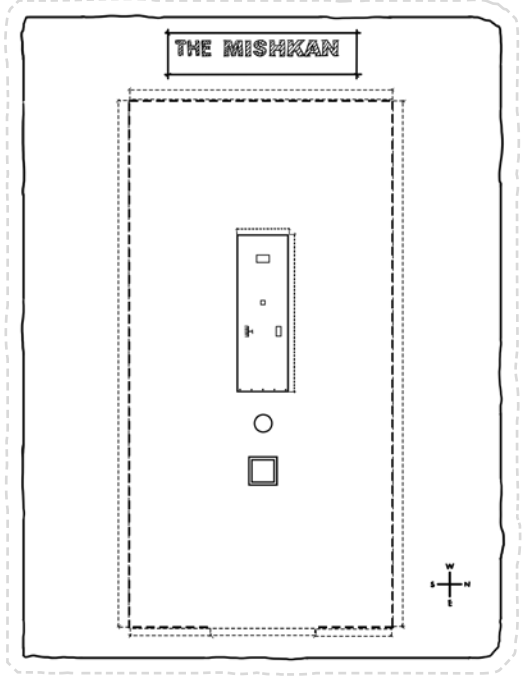

Blueprints

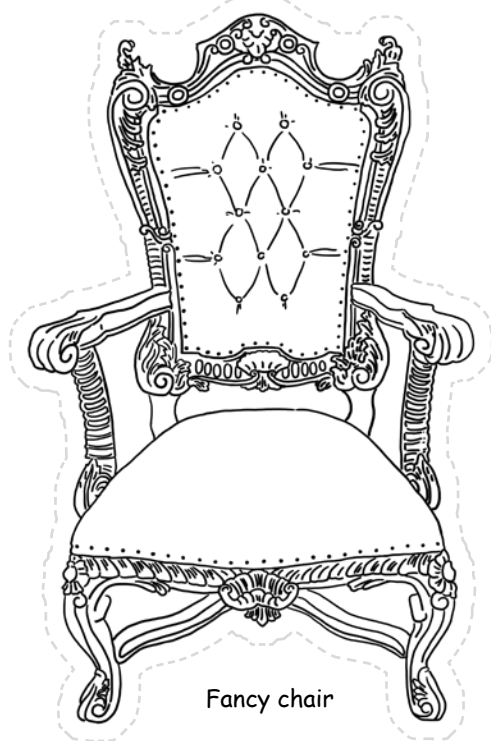

Fancy chair

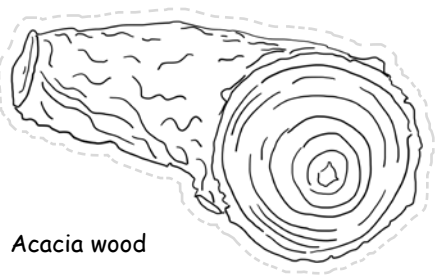

Acacia wood



Noah

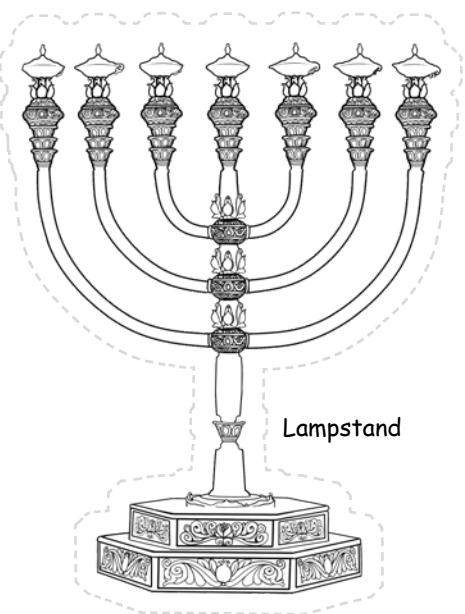

Lampstand

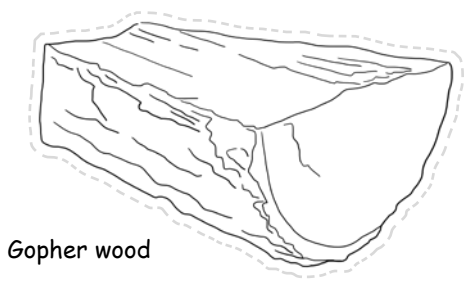

Gopher wood

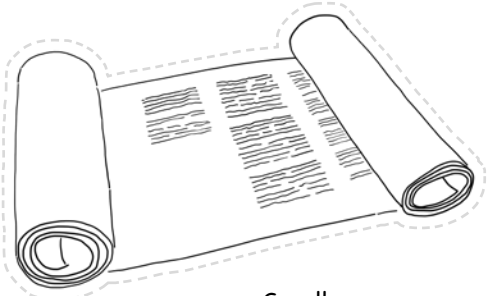

Scroll



Mountain



Treasure chest

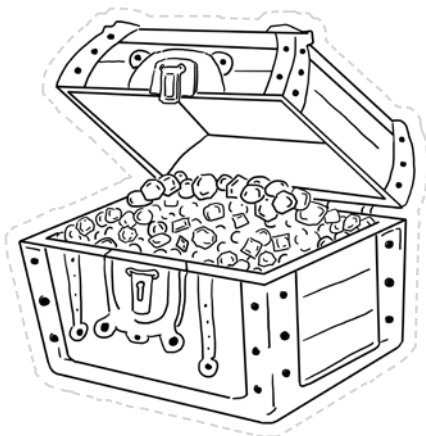

Ark of the Witness

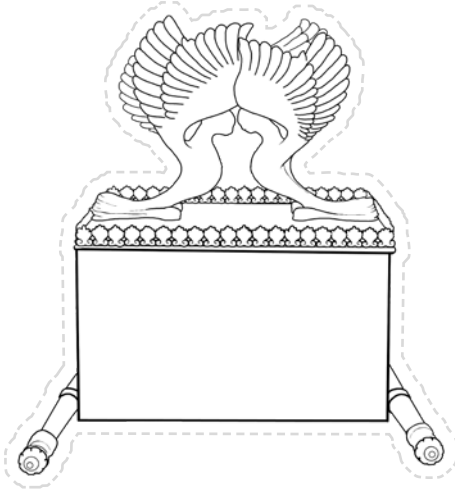
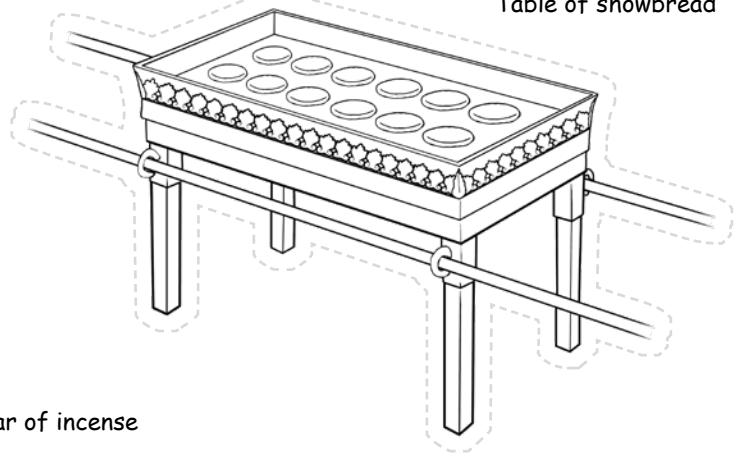

Table of showbread



Altar of incense

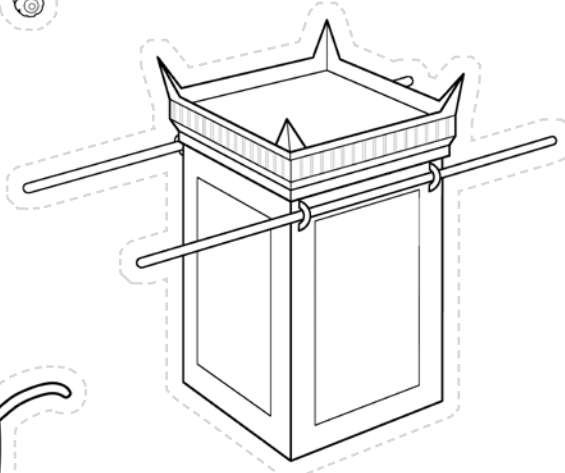

Table of showbread utensils



Incense



Olive oil

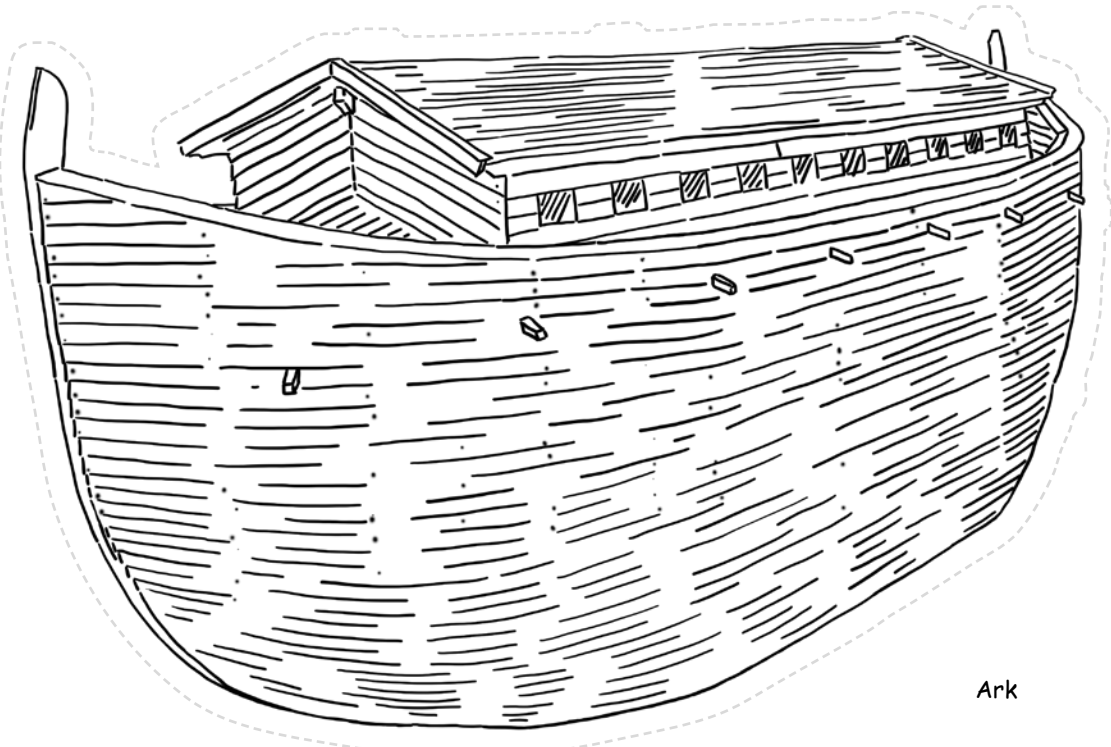
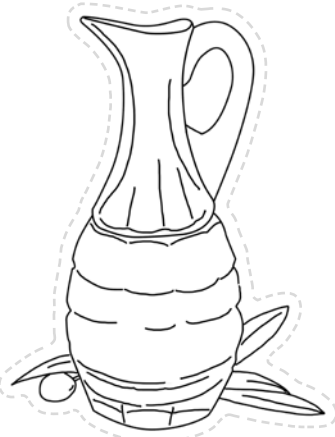

Ark

Counting What You Gained

This next section is intended to be reinforcement of the lessons learned during this parsha. Choose the activities that best fit your child.

STORING UP TREASURE IN MY HEART

The Katan Aleph memory verse for this Torah portion is Exodus 25:8. If they have not already done so, begin to help them to memorize the verse. Be creative and try acting it out, or putting it to music.

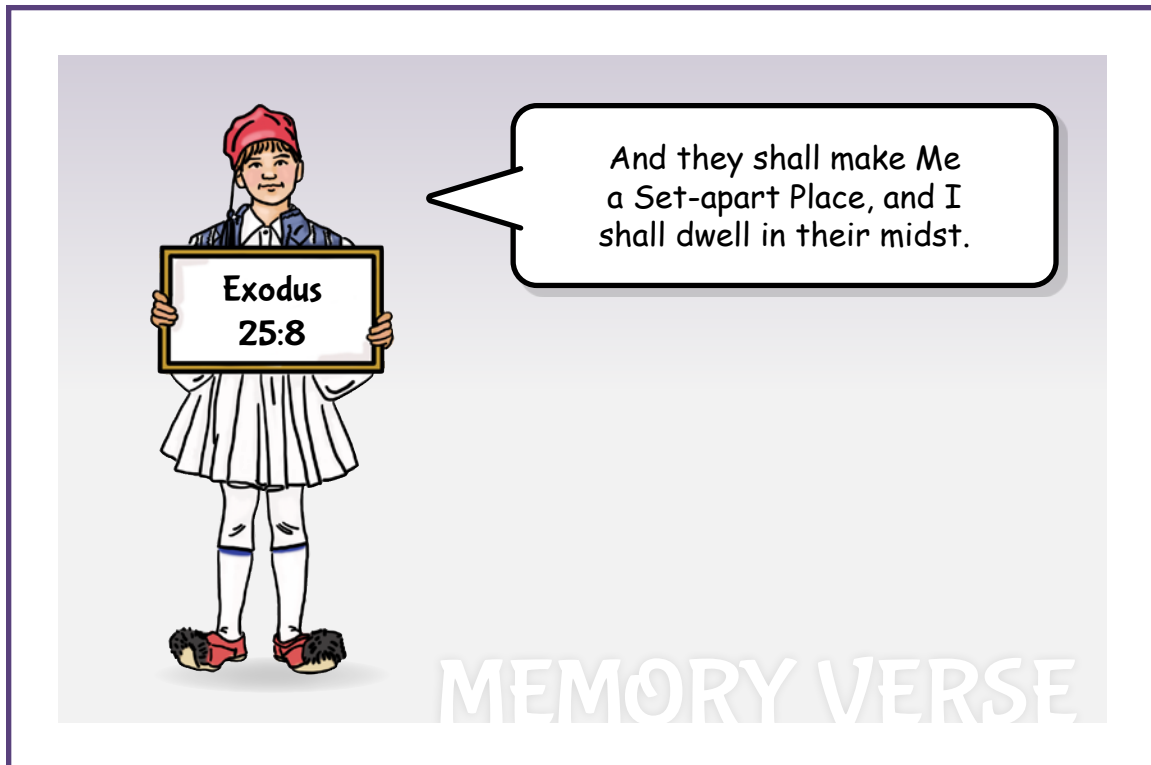

SEEKING TREASURE

Circle the correct choices.

1. Which piece of furniture had 2 kerubim on it? (25:18, 22)

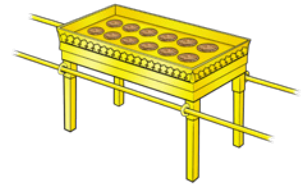
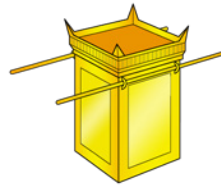

2. Which piece of furniture had showbread on it? (25:23, 30)

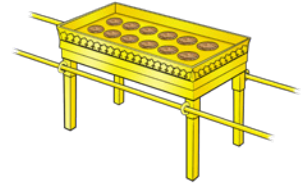
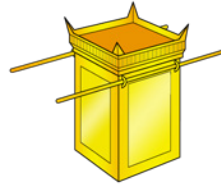

3. How many lamps were on the lampstand? (25:37)



4. What type of oil were the children of Yisra'el to provide for the lampstand? (27:20)



Almond



Coconut



Corn



Olive



Sunflower

5. Which furniture piece had incense burned on it? (30:1)

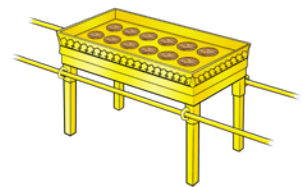
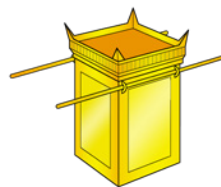

6. What type of metal was the ark, table of showbread, lampstand, and altar of incense made from? (25:11, 24, 31; 30:3)



Bronze



Copper

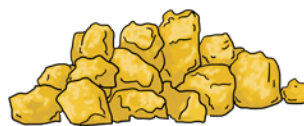

Gold



Silver

WORD SEARCH

Search for the hidden words from this week's parsha.



ARK

WITNESS

TABLE

SHOWBREAD

LAMPSTAND

INCENSE

ALTAR



MAZE

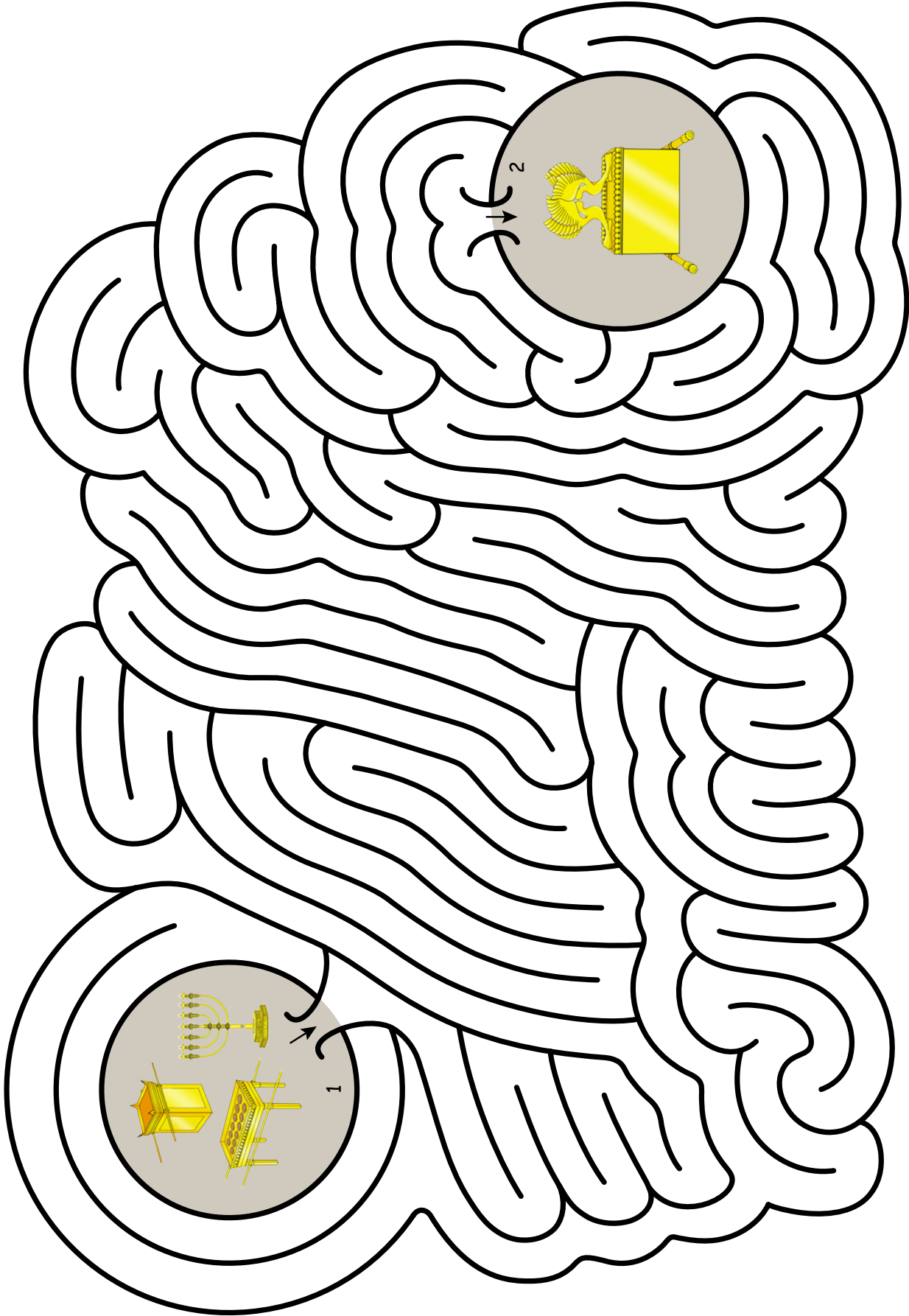

Precious Possessions

CRAFT

Materials:

- Potpourri
- Felt - color of choice
- Ribbon - color of choice
- Hot glue or Tacky glue
- Optional: other embellishments as desired

Incense Sachet

Exodus 30:34-35



Parent/Teacher Preparation:

- Assess the skill level of your child to see if you need to do any part ahead of time.

Instructions for the Craft:

- Cut felt into 2 equal square pieces - size can be what you desire.
- Glue pieces together along 3 sides. Leave one side open to insert the potpourri. (P1)
- Decorate one of the felt pieces with ribbon or other embellishments. (P2)
- When the glue is dry, insert potpourri into pouch. (P3, P4)
- Glue the final side closed. (P5)

You now have an incense sachet to remind you of the sweet fragrancd incense compound for the altar of incense.

*Note: We are not making the incense listed in Exodus 30:34-38 as Yahweh commanded that the incense was not to be duplicated. Its' ingredients were only to be used for the altar of incense.



P1



P2



P3



P4



P5



Sweetness of Torah

SWEET SOUNDS OF TORAH

(Sing Praises to His Name)

Here is the link for this song:

https://www.podomatic.com/podcasts/steveberkson/episodes/2017-02-26T06_20_20-08_00

The Mishkan Song

Yahweh said, "Build a mishkan for me
So that among you I will be"
Gifts for the mishkan, they did bring
There was a plan for everything

They brought gold and silver, too
Wool of purple, red and blue
A menorah made of gold so pure
There were curtains for the door

The aron was covered with gold
Such a sight to behold!
The shulchan, made of acacia wood
In the mishkan they stood

Mishkan - tabernacle

Menorah - 7-branch lampstand

Aron - ark of the Witness

Shulchan - table of showbread



SWEET TASTE OF TORAH

This snack relates to this week's parsha. Please take these as suggestions and make necessary changes based on your individual dietary needs.

7-Branch Lampstand (Menorah)

Exodus 25:31



Ingredients:

- Bananas (9 slices to represent main shaft)
- Blueberries (arranged to make 6 branches)
- Apples or any red fruit slices (7 cut to represent lamps)
- Orange slices (7 to represent the light)

Instructions:

Take a banana and cut approximately 9 slices. Arrange 4 as the base and the remaining 5 as main shaft. Assemble the blueberries to come out of main shaft with 3 branches on each side of equal lengths. Take the 7 red apple slices and place over branches vertically. Last, arrange the 7 orange slices over the apple slices.

Next Week's Treasure Hunt

Next Week's Torah Portion

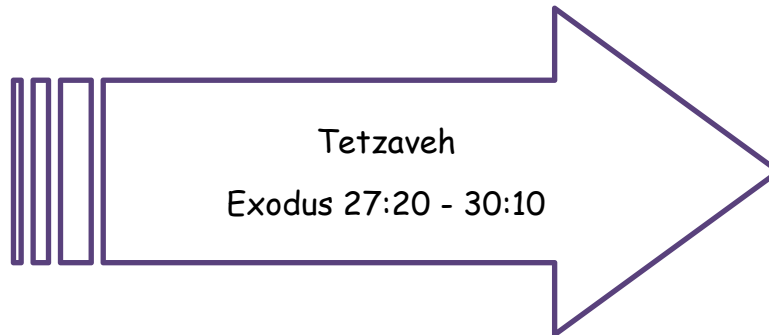

Suggested Reading Schedule

Monday:	Ex. 27:20-28:30	Oil for the lamp; Instructions for making the set-apart garments
Tuesday:	Ex. 28:31-43	Instructions for making the set-apart garments
Wednesday:	Ex. 29:1-28	Instruction for the ordination of the priests
Thursday:	Ex. 29:29-46	Instruction for the ordination of the priests
Friday:	Ex. 30:1-10	Specifications for the altar of incense